

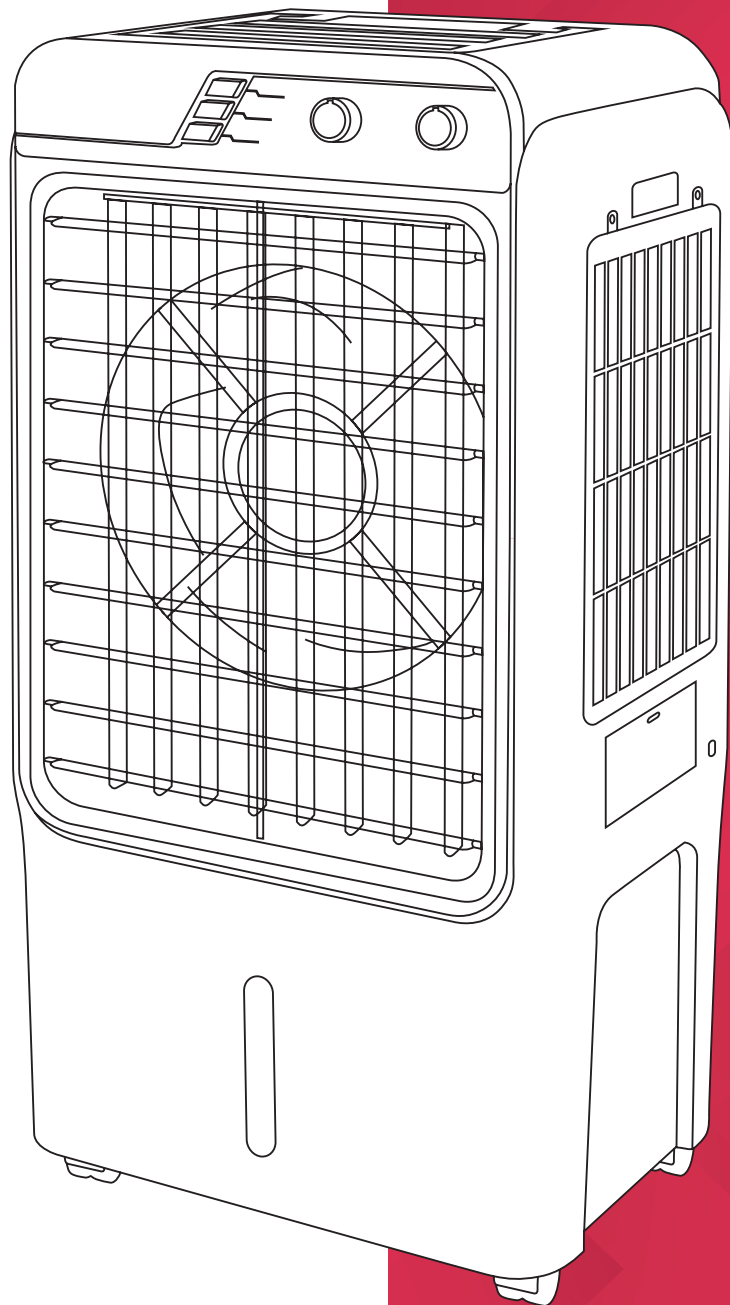

INSTRUCTION MANUAL



40L Evaporative Cooler

Model: DCEVP40M

For domestic household use
only.



IMPORTANT

THESE INSTRUCTIONS SHOULD BE READ CAREFULLY AND RETAINED FOR FUTURE REFERENCE. **Note also the information presented on the appliance**

CAUTION: FAILURE TO FOLLOW THESE INSTRUCTIONS MAY CAUSE INJURY AND/OR DAMAGE AND MAY INVALIDATE YOUR WARRANTY

Please read the operating instructions carefully before using your evaporative cooler for the first time and keep them in a safe place.

WARNING – This appliance must not be used in a bathroom.

WARNING – Do not use this appliance in the immediate surroundings of a bath, a shower or a swimming pool.

- Never immerse the appliance in water or other liquids.
- Operate this unit only on a firm, flat surface to avoid the risk of water leakage. Ensure that the unit is kept upright at all times.
- Do not place on soft, unstable or non-horizontal/angled surfaces.
- Never operate the appliance if a cable or connector has been damaged, after appliance malfunction or if the appliance was dropped or is otherwise damaged.
- If the mains lead is damaged it must only be replaced by the manufacturers service agent or a similarly qualified person in order to avoid a hazard.
- Please ask a professional service agent to repair the product. Improper repair may cause danger to users.
- Disconnect the appliance from mains power whenever it is not in use, before relocating it, and before cleaning.
- Operate the appliance only at the voltage specified on the rating label.
- Only connect the unit to a properly installed and easily accessible socket so that you can quickly disconnect the plug if necessary.
- Do not connect this product to the mains using an extension lead.
- This evaporative cooler is only intended for **INDOOR RESIDENTIAL** applications. This evaporative cooler should not be used for commercial or industrial or leisure applications or in small enclosed spaces.
- Never use the mains lead as a carrying strap or pulling lead.
- To avoid a fire or electrocution hazard, **NEVER** put the cord near heat registers, radiator, stoves or heaters.
- **DO NOT** cover cord with carpeting, throw rugs, runners, or similar coverings.
- **DO NOT** route cord under furniture or appliances. Take care to position the cord away from traffic areas and where it will not be a tripping hazard.
- **DO NOT** use the unit near windows or where water collects. Rain and water collection may lead to a risk of fire or electric shock.
- Only operate this appliance with a minimum of 50cm clearance all around i.e. away from walls, furniture and overhanging objects such as curtains or a shelf.

- This appliance is not intended for use by persons (including children) with reduced physical, sensory or mental capabilities, or lack of experience and knowledge, unless they have been given supervision or instruction concerning use of the appliance by a person responsible for their safety.
- Children should be supervised to ensure they do not play with the appliance.
- To prevent spillage, empty the water tank before lifting or relocating the appliance.
- **WARNING:** To avoid danger of suffocation please remove all packaging materials particularly plastic and EPS and keep these away from vulnerable people, children and babies.
- **NEVER** drop or insert any object or fingers into any openings.
- Do not use the appliance in locations where paint, petrol or other flammable liquids are used or stored.
- If the supply cord is damaged, it must be replaced by the manufacturer, its service agent or similarly qualified persons in order to avoid a hazard.
- Do not use bug sprays or other flammable cleansers/vapour sprays on or around the unit.
- Always switch off the unit and take the plug out of the socket:
 - If you are not using the unit
 - Before you clean or carry out maintenance on the unit
 - If a fault occurs
 - In the event of an electrical storm.
- Avoid electromagnetic interference. Keep the unit at least 1 metre away from electrical appliances such as televisions & radios.
- **DO NOT** use this appliance with an extension lead or power cord.
- **UNPLUG** the device when filling the water tank and cleaning the unit.

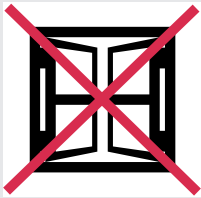

Exposed to the weather outdoors



Near water

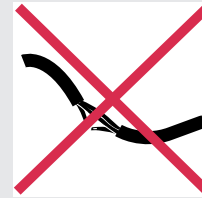

If the power cable wires are frayed or cut



Where small children may be left unattended

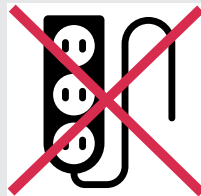

No extension leads or power cords



Where the power cable may be damaged



On a slope or uneven surface



Where there is risk of fire or close to a naked flame



Where it may be damaged by chemicals



Where there is a risk of interference by foreign objects



This product is not made for DIY repair



If there is a risk of water falling on the unit

Specification

Model no.	DCEVP40M
Colour	White/Black
Power supply	220-240V~, 50Hz
Rated power	150W
Speed settings	3
Air speed (max)	8.2m/s
Water tank capacity	40L
Remote control	N
Timer	2 hours
Swing function	Y
Controls	Manual
Noise level (max)	≤65.6dB
Weight (net)	11kg
Dimensions (w x d x h)	480 x 360 x 1000mm

- For greater precision, please always refer to the rating label placed on the product.

Parts

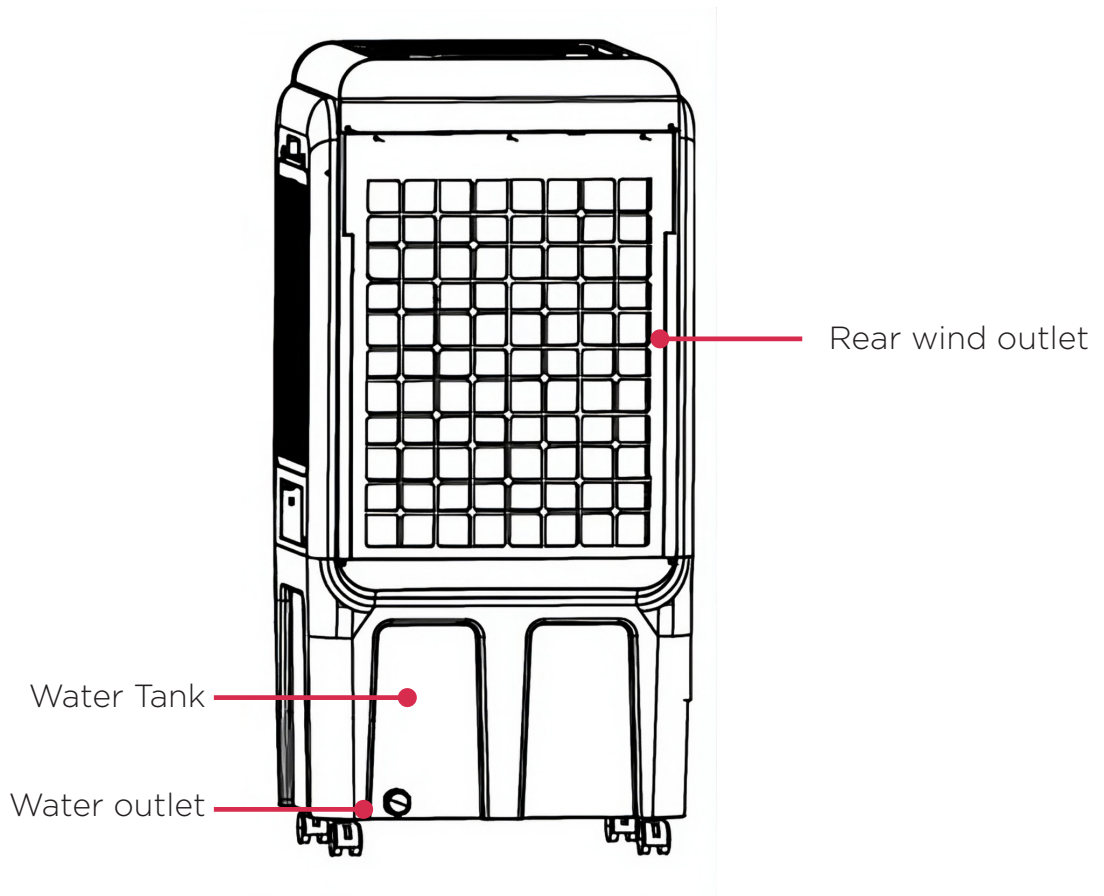
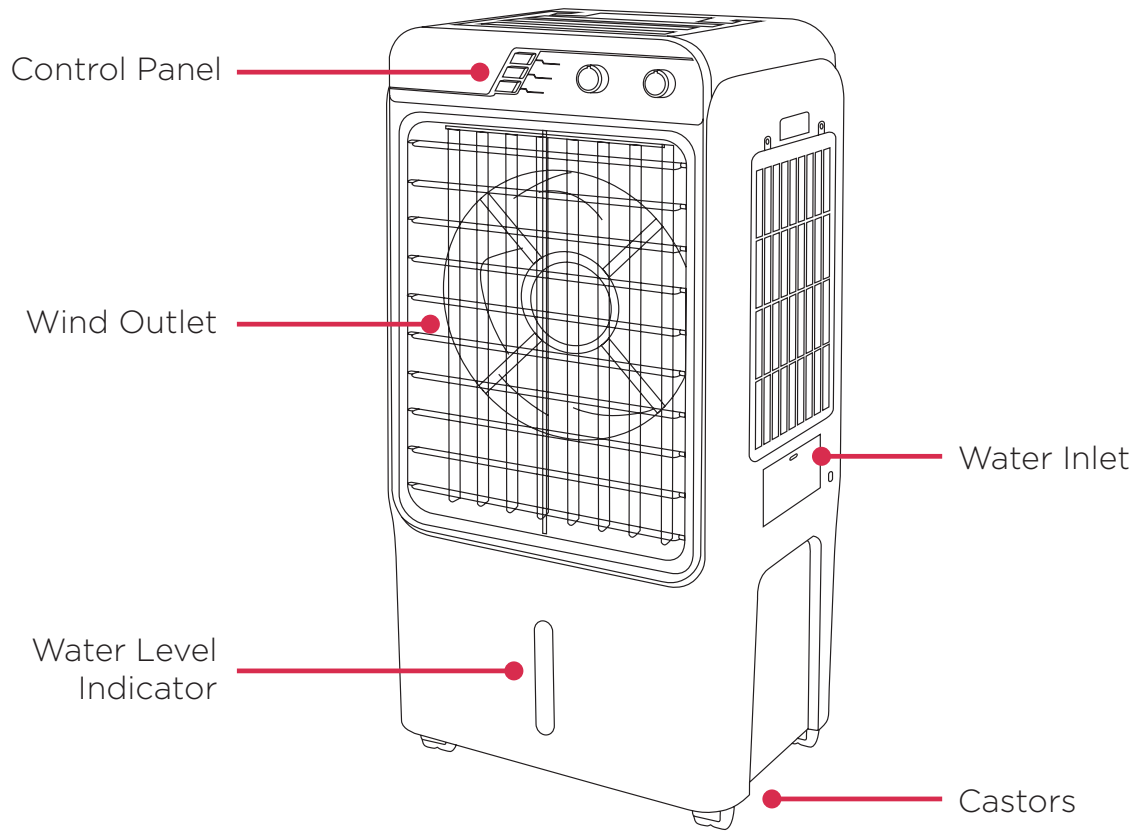

Control Panel

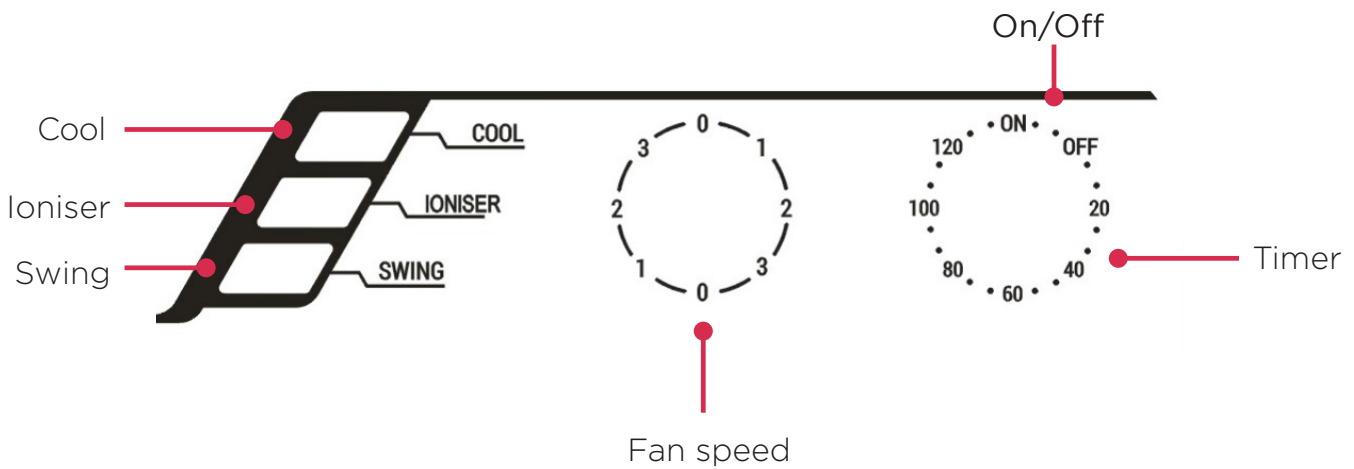

Assembly

ASSEMBLING CASTORS

1. Place the unit on a flat surface.

2. Take the supplied screws and fasten to the castors to the base of the unit.

Note: There are two castors with a brake and two castors without. The castors with a brake are intended to be installed as rear castors.

FILLING THE WATER TANK

1. Open the water inlet on the side of the unit.

2. Add clean water to the water tank.

Note: a) Pay attention to the level of the water tank when filling the unit.

b) The level of the water tank should not exceed the **MAX** level indicator

c) The level of the water tank should not fall below the **MIN** level indicator during operation.

d) Ice may be placed into the water tank to strengthen the cooling efficiency. Be careful not to exceed the **MAX** water level when doing so.

Functions

ON/OFF

Rotate the right knob to the **ON** position to turn the unit **ON**.

FAN SPEED

The **FAN SPEED** can be selected by rotating the left knob. In the following sequence: Off (0) > Low (1) > Medium (2) > High (3).

SWING FUNCTION

Press this button to turn on the **SWING** function, the louvres will move left to right and the **SWING** LED indicator light will illuminate. Press the button again to turn off the swing function.

The horizontal fins can be manually adjusted to direct air up and down.

IONISER FUNCTION

Press the **IONISER** function to start ionisation. Press the button again to disable the ioniser function.

TIMER

The **TIMER** can be set via by rotating the right knob clockwise. The steps on the knob indicate the set time in minutes, up to 120 minutes (2 hours). Once the selected time has elapsed, the unit will cease function until it is turned on once again.

COOL

Press the **COOL** button to start the cool function. Ice can be added to the water tank to strengthen the efficiency of this function. Press the button again to disable the cool function.

Operation

Filling the water tank

Unplug the appliance before filling the water tank. In order to use the cooling function, you need to fill the water tank. For your convenience, the water tank can be filled from the side of the unit saving removing the water tank.

Filling from the side

Unplug the appliance before filling the water tank. Open the water cover, and slowly pour filtered/clean water into the compartment (Fig. 1) with a jug, and then close the water cover. Ensure the total level of the water tank is filled to the **MIN** level, and does not exceed the **MAX** level indicated at the front of the unit (Fig. 2).

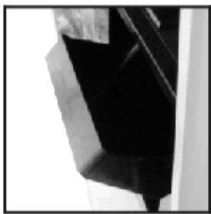

Fig. 1

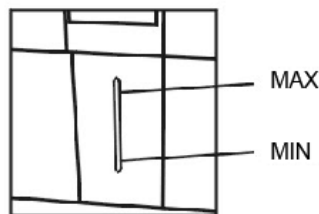

Fig. 2

Draining the water tank

If storing the unit for an extended period of time, the water tank will need to be drained.

Unplug the appliance before draining the water tank. Loosen the cap on the water outlet located at the rear of the unit (Fig. 3), and let the water inside the tank drain. The unit may need to be tilted on an angle in order to completely drain the water tank. Replace the cap before use.



Fig. 3

Outside Cabinet

1. Turn the unit OFF and disconnect the appliance from the power supply.
2. Remove any dust build up with a soft brush.
3. Wipe the surface of the unit with a soft damp cloth. Mild detergent can be used for any stubborn marks.

Do not use abrasive sponges, scouring pads, or a stiff brush to clean the unit.

IMPORTANT

The control panel and other parts must not come into contact with water or any other liquids.

Storage

If not using the unit for an extended period of time. After cleaning please:

- Turn the unit off, unplug and take care of the mains lead & plug.
- Cover the unit and store it upright in a location where it will not receive direct sunlight. NB- Prolonged exposure to direct sunlight will discolour the enclosure.

Maintenance

If the unit fails to operate efficiently, is broken or other problems arise, unplug and do not operate. Ask for advice by calling your local after sales service agent or the Customer Care Centre on 1300 556 816 (AU) / 0800 666 2824 (NZ).

Warranty

Please refer to the warranty card in the box for warranty information. For any troubleshooting advice, please contact the relative Customer Care Centre below.

Glen Dimplex Australia Pty Ltd

1340 Ferntree Gully Road,
Scoresby 3179, Victoria
Australia
Ph: 1300 556 816

Glen Dimplex New Zealand Ltd

38 Harris Road, East Tamaki,
Auckland 2013
New Zealand
Ph: 0800 666 2824

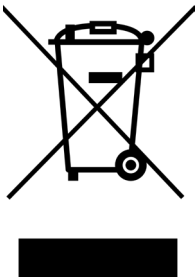

Recycling: Do not dispose of electrical appliances as unsorted municipal waste. Use separate collection facilities. Contact your local government for information regarding the collection systems available. If electrical appliances are disposed of in landfills or dumps, hazardous substances can leak into the ground water, polluting the food chain and damaging health and well-being.



Customer Care: 1300 556 816
customer.care@glendimplex.com.au
www.dimplex.com.au

Supplied by Glen Dimplex Australia
1340 Ferntree Gully Road, Scoresby, Victoria, 3179

© Glen Dimplex Australia. All rights reserved. Material contained in this publication may not be reproduced in whole or in part, without prior permission in writing of Glen Dimplex Australia.

DCEVP40M v1