

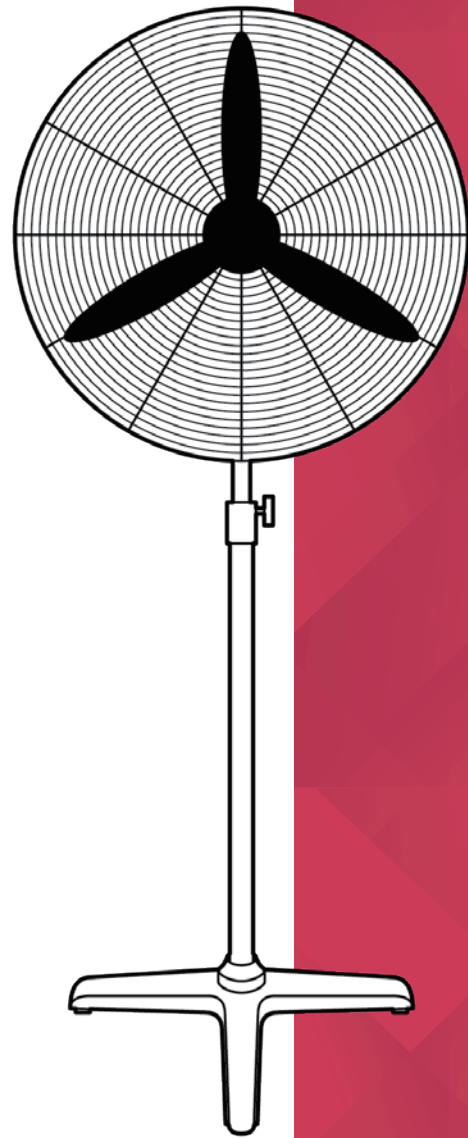

INSTRUCTION MANUAL



HV Pedestal Fan

Model: DCPF50MBK

For domestic household use only.



IMPORTANT

THESE INSTRUCTIONS SHOULD BE READ CAREFULLY AND RETAINED FOR FUTURE REFERENCE.

Note also the information presented on the appliance

CAUTION: FAILURE TO FOLLOW THESE INSTRUCTIONS MAY CAUSE INJURY AND/OR DAMAGE AND MAY INVALIDATE YOUR WARRANTY

Please read the operating instructions carefully before using your fan for the first time and keep them in a safe place.

WARNING – This appliance must not be used in a bathroom.

WARNING – Do not use this appliance in the immediate surroundings of a bath, a shower or a swimming pool.

- If the mains lead is damaged it must only be replaced by the manufacturer's service agent or a similarly qualified person in order to avoid a hazard.
- This appliance is not intended for use by persons (including children) with reduced physical, sensory or mental capabilities, or lack of experience and knowledge, unless they have been given supervision or instruction concerning use of the appliance by a person responsible for their safety.
- Children should be supervised to ensure they do not play with the appliance.
- Please ask a professional service agent to repair the product. Improper repair may cause danger to users.
- Never immerse the appliance in water or other liquids.
- Operate this unit only on a firm, flat surface.
- Do not place on soft, unstable or non-horizontal/angled surfaces.
- Never operate the appliance if a cable or connector has been damaged, after appliance malfunction or if the appliance was dropped or is otherwise damaged.
- Please ask a professional service agent to repair the product. Improper repair may cause danger to users.
- Disconnect the appliance from mains power whenever it is not in use, before relocating it, and before cleaning.
- Operate the appliance only at the voltage specified on the rating label.
- Only connect the unit to a properly installed and easily accessible socket so that you can quickly disconnect the plug if necessary.
- Do not connect this product to the mains using an extension lead.
- This fan is only intended for **INDOOR RESIDENTIAL** applications. This fan should not be used for commercial or industrial or leisure applications

or in small enclosed spaces.

- Never use the mains lead as a carrying strap or pulling lead.
- To avoid a fire or electrocution hazard, **NEVER** put the cord near heat registers, radiator, stoves or heaters.
- **DO NOT** cover cord with carpeting, throw rugs, runners, or similar coverings.
- **DO NOT** route cord under furniture or appliances. Take care to position the cord away from traffic areas and where it will not be a tripping hazard.
- **DO NOT** use the unit near windows or where water collects. Rain and water collection may lead to a risk of fire or electric shock.
- Only operate this appliance with a minimum of 50cm clearance all around i.e. away from walls, furniture and overhanging objects such as curtains or a shelf.
- **WARNING:** To avoid danger of suffocation please remove all packaging materials particularly plastic and EPS and keep these away from vulnerable people, children and babies.
- **NEVER** drop or insert any object or fingers into any openings.
- Do not use the appliance in locations where paint, petrol or other flammable liquids are used or stored.
- Do not use bug sprays or other flammable cleansers/vapour sprays on or around the unit.
- Always switch off the unit and take the plug out of the socket:
 - If you are not using the unit
 - Before you clean or carry out maintenance on the unit
 - If a fault occurs
 - In the event of an electrical storm.
- Avoid electromagnetic interference. Keep the unit at least 1 metre away from electrical appliances such as televisions & radios.

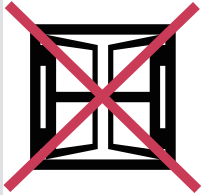

Exposed to the weather outdoors



Near water

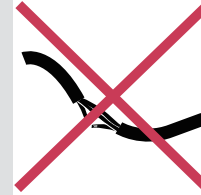

If the power cable wires are frayed or cut



Where small children may be left unattended



If an extension lead may become overloaded



Where the power cable may be damaged



On a slope or uneven surface



Where there is risk of fire or close to a naked flame



Where it may be damaged by chemicals



Where there is a risk of interference by foreign objects



This product is not made for DIY repair



If there is a risk of water falling on the unit

Specification

Model no.	DCPF50MBK
Colour	Matte Black
Power supply	220-240V~, 50Hz
Rated power	180W
Speed settings	3
Modes	-
Timer	-
Remote control	-
Adjustable height	Yes - Max. height 1.5m
Tilt adjustable head	Y
Horizontal oscillation	Y
Noise level	75dB(A)
Weight (net)	13.6kg
Dimensions (w x d x h)	570 x 550 x 1500mm

- For greater precision, please always refer to the rating label placed on the product.

Included:

- Fan
- 19mm bolt & washer
- 1 x long bolt & washer
- 4 x rear grille screws
- 1 x grub screw
- 1 x safety grill screw & bolt

Parts

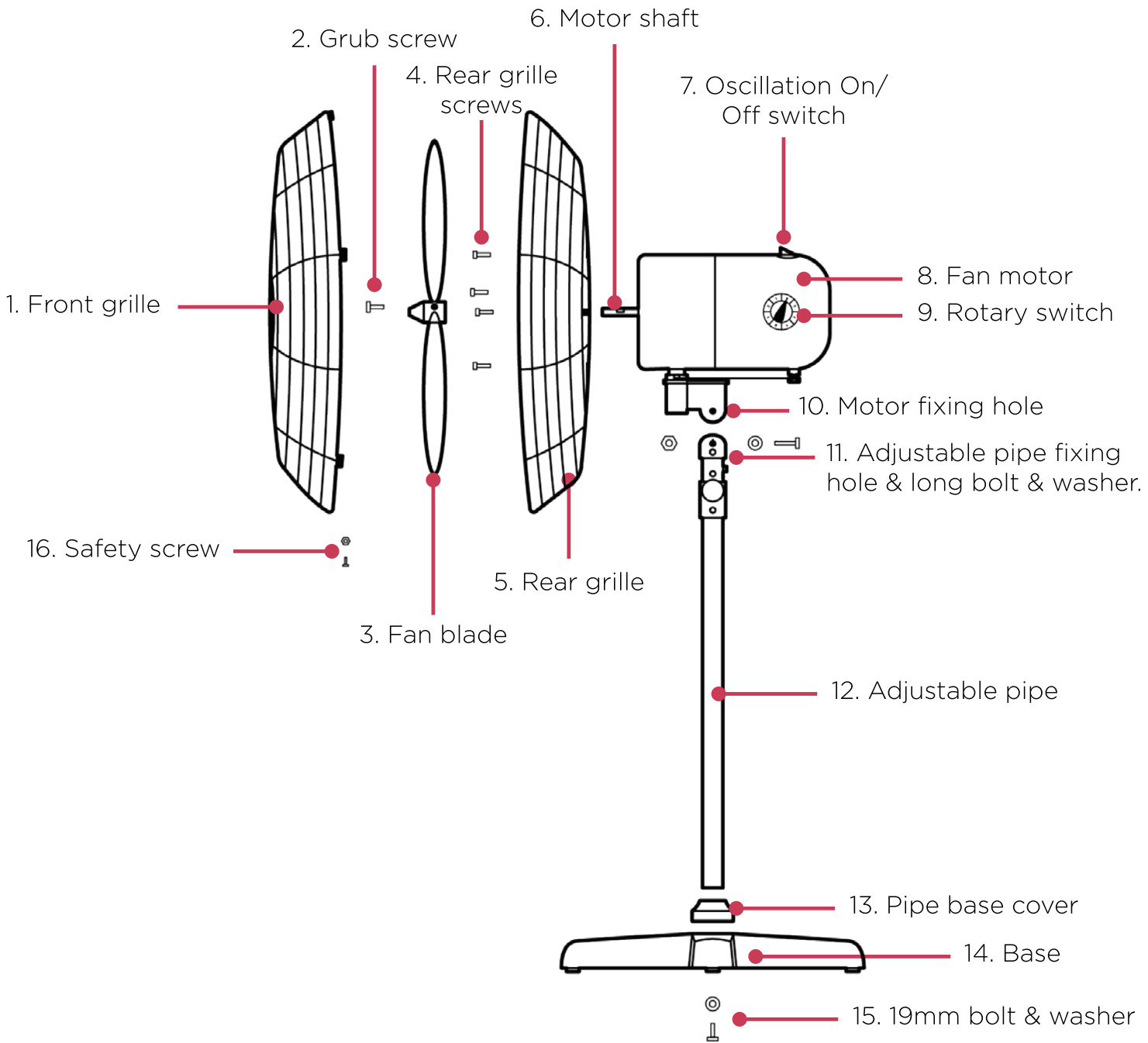

Rotary switch speed settings (9)

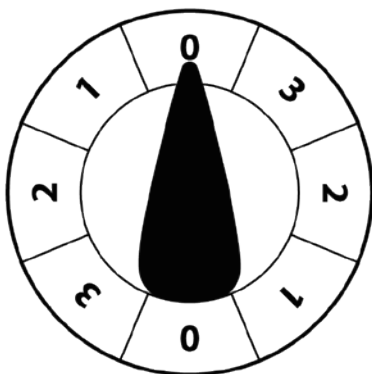

Oscillation On/Off button (7)

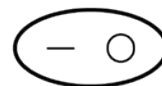

Assembly

1. Remove all parts of the fan from the box. Remove the lock nut and metal washer from the adjustable pipe fixing hole (11) and insert the pipe base cover (13) onto the adjustable pipe (12). Assemble the base (14) to the adjustable pipe (12) by holding the base on it's side, and inserting the pipe into the centre. Secure the pipe (12) to the base (14) with the supplied 19mm bolt & washer (15). Firmly tighten with a 19mm spanner (not supplied).
2. To assemble the fan motor (8) to the adjustable pipe (12) locate the motor fixing hole (10) and align with the adjustable pipe fixing hole (11). To secure the fan motor to the adjustable pipe, use the long bolt & washer (supplied) and push through the hole. Tighten the bolt well.
3. Align the rear grille (5) to motor shaft (6) on the fan motor (8) and ensure the hole for the safety screw is at the bottom. The 4 screw holes on the front of the fan motor (8) should line up. Firmly tighten all four rear grille screws (4).
4. Once the rear grille (5) is attached to the fan motor (8), turn the motor shaft (6) so the flat area is at the top. Slide the fan blade (3) all the way onto the motor shaft (6) and firmly tighten the grub screw (2) by rotating in a clockwise direction.
5. Once the fan blade is fixed, align the top locking clip on the front grille (1) so it fixes to the that of the rear grille (5). Lock the side and bottom clips in place.
TIP: the logo should be horizontal. Secure the front & rear grille, by inserting and fixing the safety screw (16) and nut.

Operation

1. Ensure the rotary switch (9) is in the '0' position, prior to connecting the plug to the power supply.
2. Switch the fan **ON** by rotating the rotary switch (9) on the back of the fan motor (8) to the desired setting - 1, 2 or 3. Turn to the '**0**' position to turn **OFF**.
3. To start oscillation, press the oscillation On/Off switch (7) to the '**I**' position. To turn oscillation off, press to '**O**' position.
4. The airflow direction can be adjusted upward/downward by lifting up or pressing down the motor housing.

NOTE: Only adjust the fan head when the unit is **OFF**. Be careful not to insert your fingers through the guard.

Over time, dust can accumulate on the front & rear grille cover and fan blades, which can affect the fans performance. It is recommended to clean the fan at least once a month.

1. Turn the unit OFF and disconnect the appliance from the power supply.
2. Remove any dust build up with a soft brush.
3. Wipe the surface of the unit with a soft damp cloth. Mild detergent can be used for any stubborn marks.

Do not use abrasive sponges, scouring pads, or a stiff brush to clean the

IMPORTANT

The control panel and other parts must not come into contact with water or any other liquids.

Storage

If not using the unit for an extended period of time. After cleaning please:

- Turn the unit off, unplug and take care of the mains lead & plug.
- Cover the unit and store it upright in a location where it will not receive direct sunlight. NB- Prolonged exposure to direct sunlight will discolour the enclosure.

Maintenance

If the unit fails to operate efficiently, is broken or other problems arise, unplug and do not operate. Ask for advice by calling your local after sales service agent or the Customer Care Centre on 1300 556 816 (AU) / 0800 666 2824 (NZ).

Warranty

Please refer to the warranty card in the box for warranty information. For any troubleshooting advice, please contact the relative Customer Care Centre below.

Glen Dimplex Australia Pty Ltd

8 Lakeview Drive,
Scoresby 3179, Victoria
Australia
Ph: 1300 556 816

Glen Dimplex New Zealand Ltd

38 Harris Road, East Tamaki,
Auckland 2013
New Zealand
Ph: 0800 666 2824

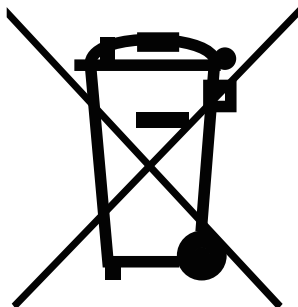

Recycling: Do not dispose of electrical appliances as unsorted municipal waste. Use separate collection facilities. Contact your local government for information regarding the collection systems available. If electrical appliances are disposed of in landfills or dumps, hazardous substances can leak into the ground water, polluting the food chain and damaging health and well-being.



Customer Care: 1300 556 816
customer.care@glendimplex.com.au
www.dimplex.com.au

Supplied by Glen Dimplex Australia
8 Lakeview Drive, Scoresby, Victoria, 3179

© Glen Dimplex Australia. All rights reserved. Material contained in this publication may not be reproduced in whole or in part, without prior permission in writing of Glen Dimplex Australia.

DCPF50MBK v1