

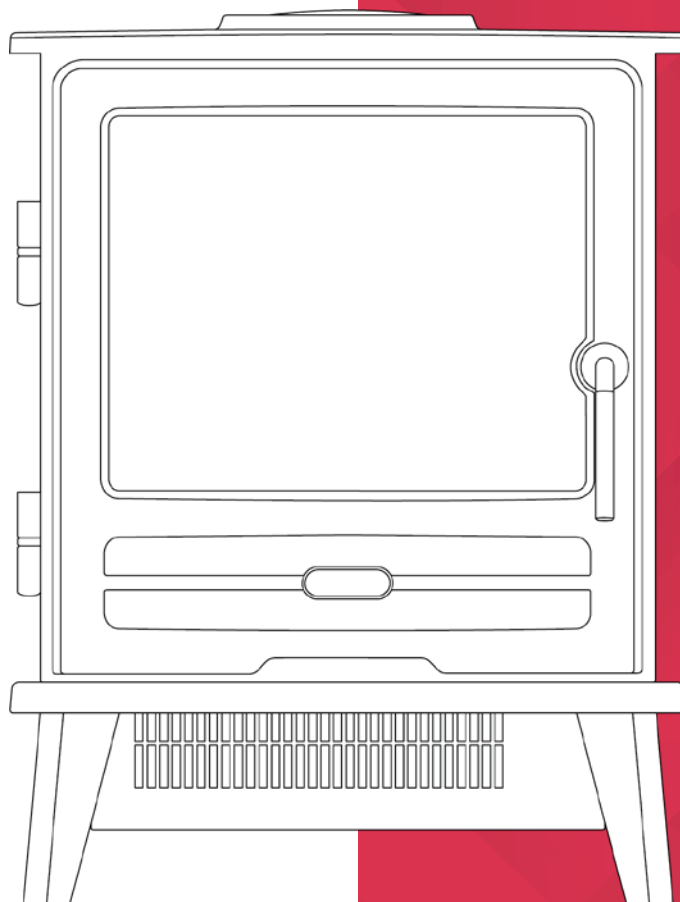

INSTRUCTION MANUAL



Willowbrook 2kW Opti-myst Portable Electric Stove

Model: WLL20-AU

For domestic household use only.



IMPORTANT

THESE INSTRUCTIONS SHOULD BE READ CAREFULLY AND RETAINED FOR FUTURE REFERENCE.

CAUTION: FAILURE TO FOLLOW THESE INSTRUCTIONS MAY CAUSE INJURY AND/OR DAMAGE AND MAY INVALIDATE YOUR WARRANTY

Please read the operating instructions carefully before using your product for the first time and keep them in a safe place.

- When using electrical appliances, basic precautions should always be followed to reduce the risk of fire, electrical shock and injury to persons, including the following:
- If the appliance is damaged, check with the supplier before installation and operation.
 - Do not use outdoors.
 - Do not use in the immediate surroundings of a bath, shower or a swimming pool.
 - Do not use this heater if it has been dropped.
 - Do not use if there are visible signs of damage to the heater.
 - Use this heater on a horizontal and stable surface, or fix it to the wall, as applicable.
- Do not locate the appliance immediately below a fixed socket outlet or connection box.
- This appliance is not intended for use by persons (including children) with reduced physical, sensory or mental capabilities, or lack of experience and knowledge, unless they have been given supervision or instruction concerning use of the appliance by a person responsible for their safety.
- Children should be supervised to ensure that they do not play with the appliance.
- Do not use this appliance in series with a thermal control, a program controller, a timer or any other device that switches on the heat automatically, since a fire risk exists when the appliance is accidentally covered or dis-placed.
- In the event of a fault, unplug the appliance.
- Unplug the appliance when not required for long periods.
- This product is only intended for **INDOOR RESIDENTIAL** applications only.
- **DO NOT** cover cord with carpeting, throw rugs, runners, or similar coverings.
- **DO NOT** route cord under furniture or appliances. Take care to position the cord away from traffic areas and where it will not be a tripping hazard.
- This appliance must not be used in a bathroom.

- Although this appliance complies with safety standards, we do not recommend its use on deep pile carpets or on long hair type of rugs
- The appliance must be positioned so that the plug is accessible.
- If the supply cord is damaged it must be replaced by the manufacturer or service agent or a similarly qualified person in order to avoid a hazard.
- Keep the supply cord away from the front of the appliance.
- Do not use this heater in small rooms when they are occupied by persons not capable of leaving the room on their own, unless constant supervision is provided.
- To reduce the risk of fire, keep textiles, curtains and or flammable material a minimum distance of 1m from the air outlet.
- In order to avoid overheating, **DO NOT COVER** the appliance. Do not place material or garments on the appliance, or obstruct the air circulation around the appliance, for instance by curtains or furniture, as this could cause overheating and a fire risk.
-  This Heater carries the warning symbol indicating that it must not be covered.
- In order to avoid a hazard due to inadvertent resetting of the thermal cut-out, this appliance must not be supplied through an external switching device, such as a timer, or connected to a circuit that is regularly switched on and off by the utility.
- **CAUTION** Some parts of this product can become very hot and cause burns. Particular attention has to be given where children and vulnerable people are present.
- Children shall not turn on/off the appliance.
- Ensure that furniture, curtains or other combustible material are positioned no closer than 1 metre from the appliance.
- Unplug the appliance when not required for long periods.
- Keep the supply cord away from the front of the appliance.
- This product is only suitable for well insulated rooms or occasional use.

WARNING: KEEP BATTERIES OUT OF REACH OF CHILDREN

- Swallowing may lead to serious injury in as little as 2 hours or death, due to chemical burns and potential perforation of the oesophagus.
- If you suspect your child has swallowed or inserted a button battery immediately call the 24-hour Poisons Information Centre on 13 11 26 (in Australia) or 0800 764 766 (in New Zealand) for fast, expert advice.
- Examine devices and make sure the battery compartment is correctly secured, e.g. that the screw or other mechanical fastener is tightened. Do not use if the compartment is not secure.
- Dispose of used button batteries immediately and safely. Flat batteries can still be dangerous.

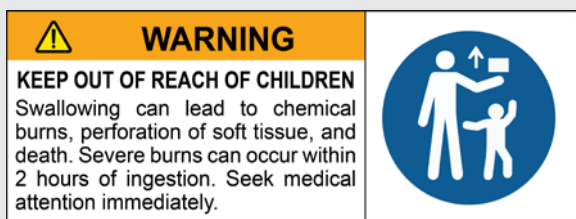

CAUTION: No obvious symptoms

Unfortunately, it is not obvious when a button or coin battery is stuck in a child's oesophagus (food pipe).

There are no specific symptoms associated with this. The child might:

- cough, gag or drool a lot
- appear to have a stomach upset or virus
- be sick
- point to their throat or stomach
- have a pain in their abdomen, chest or throat
- be tired or lethargic
- be quieter or more clingy than usual or otherwise 'not themselves'
- lose their appetite or have a reduced appetite
- not want to eat solid food/be unable to eat solid food

These types of symptoms vary or fluctuate, with the pain increasing and then subsiding.

A specific symptom to button and coin battery ingestion is vomiting fresh (bright red) blood. If the child does this seek immediate help. The lack of clear symptoms is why it is important to be vigilant with 'flat' or spare button or coin batteries in the home and the products that contain them.



Exposed to the weather outdoors



Near water



If the power cable wires are frayed or cut



Where small children may be left unattended

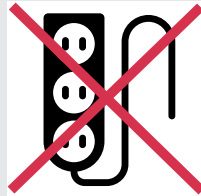

No extension leads or power boards



Where the power cable may be damaged



On a slope or uneven surface



Where there is risk of fire or close to a naked flame



Where it may be damaged by chemicals



Where there is a risk of interference by foreign objects



This product is not made for DIY repair



If there is a risk of water falling on the unit

Specifications

Model no.	WLL20-AU
Colour/Finish	Black
Wattage	2000
Heat Settings	2
Thermostat Control	Yes
Remote Control	Yes
Warranty	2 Years
Dimensions (w x d x h)	440 x 305 x 582mm

For greater precision, please always refer to the rating label placed on the product.

Product Dimensions

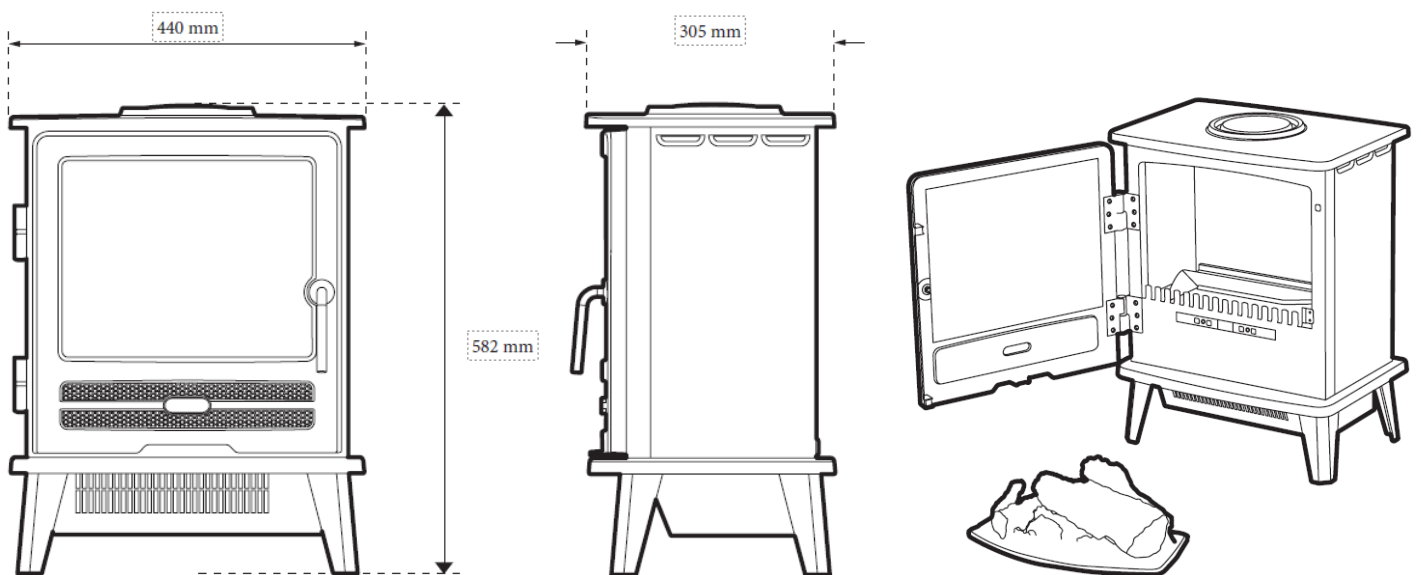

General Information

The fire incorporates a flame effect, which can be used with or without heat, so that the comforting effect may be enjoyed at any time of the year.

To reduce heat loss and to prevent any chimney up draft affecting the operation of your stove fire, we recommend that the chimney flue is sealed off. A fan heater can provide heating in cold weather. A distance of 1 metre (3 feet) must be maintained between the front of the heater and any surrounding furniture, overhanging curtains or other obstructions.

Always ensure that the appliance is sitting on a level surface.

Before connecting the appliance, check that the supply voltage is the same as that stated on the appliance.

Only use filtered water in this appliance.

Once installed, never move this appliance or lay it on its back, without draining the water from the sump and water tank. The water tank, sump, sump lid, tank cap and air filters must be cleaned once every week, particularly in hard water areas. If you intend on not using the appliance for longer than 1 week, drain the water from the sump and water tank and dry the sump.

Please note: Used in an environment where background noise is very low, it may be possible to hear a sound which is related to the operation of the fan heater & flame effect. This is normal and should not be a cause for concern.

The sump and water tank in this product are treated with a biocidal product, being Silver Biocide, in order to control harmful or unwanted organisms. This conforms with the latest relevant ISO standard, Do not drink water from the sump or from the tanks.

Electrical Connection

⚠ WARNING: THIS APPLIANCE MUST BE EARTHED

This heater must be used on an AC ~ supply only and the voltage marked on the heater must correspond to the supply voltage. Before switching on, please read the safety warnings at the start of the instruction manual and operating instructions to follow. Please retain this user's guide for future reference

If you settle this appliance in an existing chimney space, we recommend that;

1. You have your chimney cleaned by a competent chimney sweep.
2. You block off the chimney flue.

This procedure is important for the efficient operation of the heating unit and will also reduce heat loss up the chimney.

Ensure that all packing items are removed (read any warning labels carefully). Retain all packing for possible future use e.g. in the event of moving or returning the appliance to your supplier.

WARNING: FALLING OR TIPPING APPLIANCES CAN CAUSE INJURY OR DEATH OF YOUNG CHILDREN, PLEASE ENSURE CHILDREN DO NOT CLIMB, HANG OR STAND ON THIS PRODUCT.

Thermal Safety Cut-out

A thermal safety cut-out is incorporated in the fan heater to prevent damage due to overheating. This can happen if the heat outlet was restricted in any way. If the cut-out operates, unplug the heater from the socket outlet and allow approximately 10 minutes before reconnecting. Before switching the heater back on remove any obstruction that may be restricting the heat outlet, then continue normal operation.

WARNING: In order to avoid a hazard due to inadvertent resetting of the thermal cut-out, this appliance must not be supplied through an external switching device, such as a timer, or connected to a circuit that is regularly switched on and off by the utility.

Installation

Installing the Appliance

1. Clean the area where the fire will be installed e.g. remove ash residue from an existing fireplace.
2. Hold the fire by the sides of the surround and gently manoeuvre into position.
3. Plug the fire into a 10amp/230 volt outlet. Ensure that the supply cable is not trapped under the fire such that it might cause it to be damaged.

Connecting the Transducer

1. Open the stove door.
2. Gently lift out the fuel bed and carefully set aside (Fig 4).
3. Remove the water tank by lifting upwards and outwards (Fig 5).
4. Remove the nozzle by unclipping and lifting upwards and outwards (Fig 6).
5. The transducer will be inside the sump. Remove from its bag.
6. Place the Transducer unit into the sump and make the connection.
7. Locate the tab on the Transducer unit into the moulded recess in the base of the sump (Fig 7A).
8. Ensure that the cable does not obstruct the Transducer disc. To prevent the cable becoming pinched between the nozzle and the sump, place the cable in the slot in the wall of the sump (Fig 7B).

Fig. 4

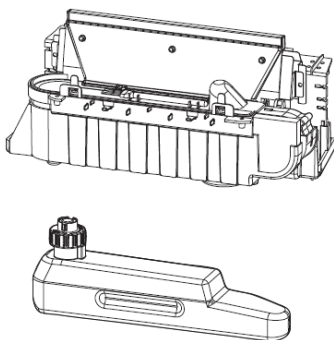

Fig. 5

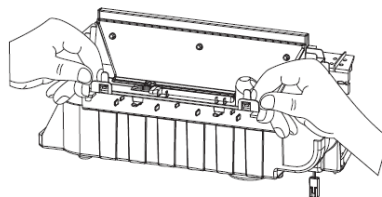

Fig. 6

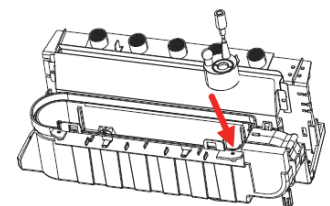
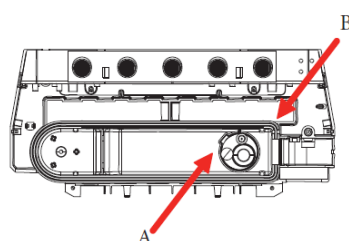

Fig. 7



Filling the Water Tank

1. Gently lift out the fuel bed and carefully set aside.
2. Remove the water tank by lifting upwards and outwards.
3. Place the water tank in the sink and remove the cap. Turn anti-clockwise to open (Fig 8).
4. Fill the tank with filtered tap water only. This is necessary to prolong the life of the flame and smoke producing unit. The water should be filtered through a conventional domestic water filter unit and the filter should be replaced regularly.
5. Screw the cap back on, ensuring to not over-tighten.
6. Return the tank to the sump, with the tank cap facing down.
7. Gently place the fuel bed back into position.

Note: When the water tank is empty, the flame and smoke effect shuts off. You will hear 2 audible beeps and the digital display will display .

Fig. 8

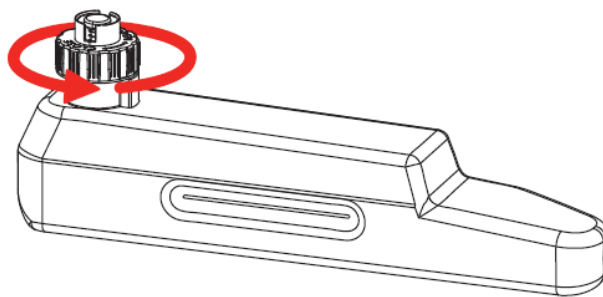

Control Panel & Remote

WARNING: FAILURE TO FOLLOW THESE OPERATING INSTRUCTIONS MAY RESULT IN INJURY AND/OR DAMAGE.

Remote control

The maximum range of use is ~ 5 metres.

WARNING: It takes time for the receiver to respond to the transmitter. Do not press the buttons more than once within two seconds for correct operation.

NOTE: The receiver for the remote control is located in the display, aim the remote control in this direction when inputting demands.

1. To activate the remote control remove the battery isolation strip, which is used to ensure your remote control reaches you fully charged.
2. To replace the remote control battery, turn over the remote control, and follow the diagram embossed on the remote control
3. Only use CR2025 size batteries.

To replace the battery:

1. Remove the screw, push down on the battery cover located on the back of the remote control. Slide the battery cover open.
2. Install 1 x 3V CR2025 Lithium battery in the battery holder. The positive (+) side of the battery faces up.
3. Close the battery cover and replace the screw



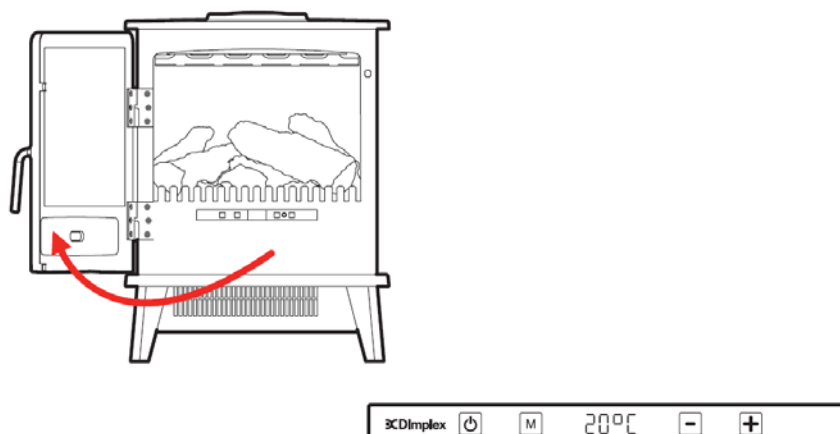

Discard leaking batteries:

Dispose of batteries in the proper manner according to provincial and local regulations. Any battery may leak electrolyte if mixed with a different battery type, if inserted incorrectly, if all batteries are not replaced at the same time, if disposed on a fire, or if an attempt is made to change a battery not intended to be recharged.

Control Panel:











Operating Instructions

	But-ton	Display	Func-tion	Description
A		-ON-	On/ Standby	Press this button once to turn on the product. Press it again to turn off the product. When turned on, you will hear a beep and the digital display will show the 'ON,' icon, followed by displaying the current room temperature. The display will then turn off. The main LED lights will activate. Be careful not to look directly into the LED's. Although the mains lights operate immediately, it will take a further 45 seconds before the flame effect starts.
B		HEAT	Con-trols fan heater	Press the 'Mode' button once for 'Heat' mode. The display will show the current setting. Using the '+' and '-' buttons you can turn the heat on at the 'Low' or 'High' setting and turn the heat off. You will hear 2 beeps for 'Low' heat setting and 3 beeps for 'High' heat setting. You will hear 1 beep when the heat is turned off. Press the 'Mode' button twice for 'Thermostat' mode. The display will show the current room temperature and then the set point temperature. Using the '+' and '-' buttons you can adjust the set point temperature up and down. If the set point temperature is below the room temperature, the heat function will not operate. The temperature range is from 15-35°C. Press the 'Mode' button three times for 'Fire' mode. The display will show the Fire icon followed by the current fire effect setting. There are 6 fire settings. Using the '+' and '-' buttons you can adjust the height of the flame effect.
		-□□-	Thermo-stat	
		FIRE	Flame intensity	
C		Setting/ Tempera-ture	De-crease Setting/ Tempera-ture	Press this button to decrease the mode or temperature the device is currently running on.
D		Setting/ Tempera-ture	Increase Setting/ Tempera-ture	Press this button to increase the mode or temperature the device is currently running on.

Remote Operation

Operating Instructions

	But-ton	Display	Func-tion	Description
A		-00-	On/ Standby	Press this button once to turn on the product. Press it again to turn off the product. When turned on, you will hear a beep and the digital display will show the 'ON,' icon, followed by displaying the current room temperature. The display will then turn off. The main LED lights will activate. Be careful not to look directly into the LED's. Although the mains lights operate immediately, it will take a further 45 seconds before the flame effect starts.
B		-LO- -HI-	Heat Setting	Press this button once to activate the 'Low' heat setting. Press it again to activate the 'High' heat setting. If you continue to press this button you will cycle through the 'Low' and 'High' heat settings. You will hear 2 beeps for 'Low' heat setting and 3 beeps for 'High' heat setting.
C		-	Heat Off	Press this button once to turn off the heat. You will hear 1 beep.
D		Room & set point temps	Display temper- atures	Press this button to display the current room temperature followed by the current set point temperature.
F		Set Point Temp	De- crease Set Point Temper- ature	Press this button to decrease the set point temperature. If the set point temperature is below the room temperature, the heat function will not operate. The temperature range is from 15-35°C.
G		Set Point Temp	Increase Set Point Temper- ature	Press this button to increase the set point temperature. If the set point temperature is below the room temperature, the heat function will not operate. The temperature range is from 15-35°C.
H		FIRE	Increase Fire Set- ting	Press this button to increase the 'Fire' setting.
I		FIRE	De- crease Fire Setting	Press this button to decrease the 'Fire' setting.

Operation

Setting the Thermostat

Plug in the product and press the 'On' button. Press the 'Mode' button twice to enter the thermostat mode. The current room temperature will be displayed (e.g. 23C) followed by the current set point room temperature (e.g. 26C). Press the '+' and '-' buttons to select your set point room temperature. Allow the display to turn off. Press the 'Mode' button once to enter the 'Heat' option. Press the '+' and '-' buttons to select either 'Low' or 'High' heat output. The heater will turn on when your set point room temperature is higher than the room temperature.

Getting the Desired Flame Effect

1. Using the manual controls or the remote control choose a 'Fire' setting between F1 and F6, F1 being the lowest setting and F6 being the highest setting.
2. Generally the flames appear more realistic when the flame control is turned down.
3. Give the flame generator time to react to changes you have made.
4. The fire will use less water if the flame effect is set to a lower level.
5. Do not tilt or move the fire while there is water in the tank or sump.
6. Make sure that the fire is on a level floor.

Cleaning

Over time, dust can accumulate which can effect performance. It is recommended to clean the unit at least once a month.

CAUTION: ALWAYS Turn the unit **OFF** and disconnect the appliance from the power supply before undergoing any cleaning and maintenance.

The surfaces of the heater should be given an occasional wipe with a dry soft cloth. **Do not** use detergents, abrasive cleaning powder or furniture polish as this can damage the surface of the product.

The glass door should be cleaned carefully with a chamois leather. **Do not** use proprietary cleaners.

To remove any accumulation of dust or fluff, the soft brush attachment of a vacuum cleaner should occasionally be used to clean the outlet grille of the fan heater located under the stoves main body.

Water Tank

1. Remove the water tank, as described earlier, and put into the sink and empty the water.
2. Using the supplied brush, gently run the inside surfaces of the cap, paying particular attention to the rubber ring in the outer groove and the centre rubber seal.
3. Put a small quantity of washing liquid into the tank, refit the cap and shake well, then rinse out until all traces of washing liquid are gone.
4. Refill with filtered tap water only, replace the cap, ensuring to not over tighten.

Sump

1. Press the 'On' button to put the product into standby.
2. Gently lift out the fuel bed and place carefully on the ground.
3. Remove the water tank by lifting upwards.
4. Remove the sump lid to allow the sump to be lifted completely from its location (Fig 5).
5. Carefully tilt so that the liquid drains out of the sump.
6. Put a small amount of washing liquid into the sump, and using the supplied brush, gently clean all surfaces including the metal disc (Fig 9).
7. When cleaned, thoroughly rinse the sump with clean water.
8. Clean the outlet surface of the sump lid with the brush and flush out thoroughly with water.
9. Reverse the above steps to reassemble.

Fig. 5

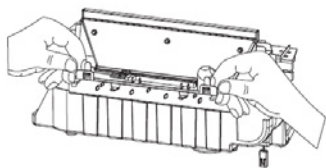

Fig. 9

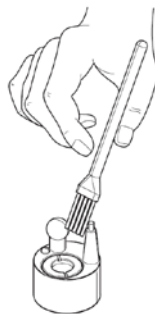
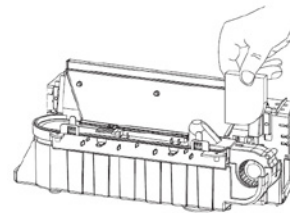

Fig. 10



Air Filter

1. Press the 'On' button on the remote control or manually to switch off.
2. Gently lift off the fuel bed and set aside.
3. Remove the tank and place in a sink with the cap facing upwards.
4. Gently slide up the air filter (Fig 10).
5. Gently rinse with water in the sink and dry with a fabric towel before returning.
6. Replace the filter making sure that the coarse black filter is in contact with the plastic holder.
7. Replace the tank.
8. Replace the fuel bed.
9. Press the 'On' button to turn on the product.

Warranty

Please refer to the warranty card in the box for warranty information. For any troubleshooting advice, please contact the relative Customer Care Centre below.

Glen Dimplex Australia Pty Ltd

8 Lakeview Drive,
Scoresby 3179, Victoria
Australia
Ph: 1300 556 816

Glen Dimplex New Zealand Ltd

38 Harris Road, East Tamaki,
Auckland 2013
New Zealand
Ph: 0800 666 2824



Recycling: Do not dispose of electrical appliances as unsorted municipal waste. Use separate collection facilities. Contact your local government for information regarding the collection systems available. If electrical appliances are disposed of in landfills or dumps, hazardous substances can leak into the ground water, polluting the food chain and damaging health and well-being.



Customer Care: 1300 556 816
customer.care@glendimplex.com.au
www.dimplex.com.au

Supplied by Glen Dimplex Australia
8 Lakeview Drive, Scoresby, Victoria, 3179

© Glen Dimplex Australia. All rights reserved. Material contained in this publication may not be reproduced in whole or in part, without prior permission in writing of Glen Dimplex Australia.

WLL20-AU v7