

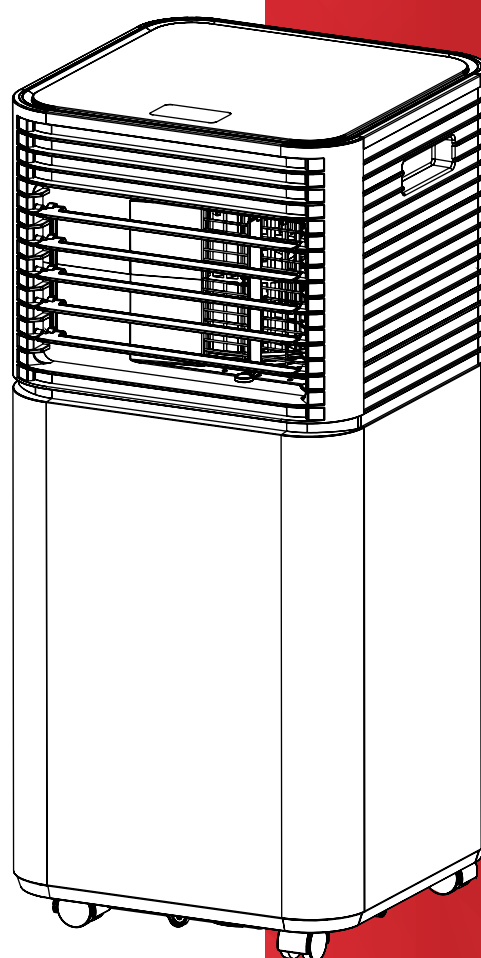

INSTRUCTION MANUAL



Portable Air Conditioner

Model: DPRC20ECO-A

For domestic household use only.



IMPORTANT

THESE INSTRUCTIONS SHOULD BE READ CAREFULLY AND RETAINED FOR FUTURE REFERENCE.

Note also the information presented on the appliance

CAUTION: FAILURE TO FOLLOW THESE INSTRUCTIONS MAY CAUSE INJURY AND/OR DAMAGE AND MAY INVALIDATE YOUR WARRANTY

Please read the operating instructions carefully before using your Portable Air Conditioner for the first time and keep them in a safe place.

WARNING - This appliance must not be used in a bathroom.

WARNING - Do not use this appliance in the immediate surroundings of a bath, a shower or a swimming pool.

- If the mains lead is damaged it must only be replaced by the manufacturers service agent or a similarly qualified person in order to avoid a hazard.
- This appliance is not intended for use by persons (including children) with reduced physical, sensory or mental capabilities, or lack of experience and knowledge, unless they have been given supervision or instruction concerning use of the appliance by a person responsible for their safety.
- Children should be supervised to ensure they do not play with the appliance.
- Prior to cleaning or other maintenance, the appliance must be disconnected from the supply mains.
- Never immerse the appliance in water or other liquids.
- Operate this unit only on a firm, flat surface to avoid the risk of water leakage. Ensure that the unit is kept upright at all times.
- Do not place on soft, unstable or non-horizontal/angled surfaces.
- Never operate the appliance if a cable or connector has been damaged, after appliance malfunction or if the appliance was dropped or is otherwise damaged.
- Please ask a professional service agent to repair the product. Improper repair may cause danger to users.
- Disconnect the appliance from mains power whenever it is not in use, before relocating it, and before cleaning.
- Operate the appliance only at the voltage specified on the rating label.
- Only connect the unit to a properly installed and easily accessible socket so that you can quickly disconnect the plug if necessary.
- Do not connect this product to the mains using an extension lead.
- This product is only intended for **INDOOR RESIDENTIAL** applications. This product should not be used for commercial or industrial or leisure applications or in small enclosed spaces.
- Never use the mains lead as a carrying strap or pulling lead.

- To avoid a fire or electrocution hazard, **NEVER** put the cord near heat registers, radiator, stoves or heaters.
- **DO NOT** cover cord with carpeting, throw rugs, runners, or similar coverings.
- **DO NOT** route cord under furniture or appliances. Take care to position the cord away from traffic areas and where it will not be a tripping hazard.
- **DO NOT** use the unit near windows or where water collects. Rain and water collection may lead to a risk of fire or electric shock.
- Only operate this appliance with a minimum of 50cm clearance all around i.e. away from walls, furniture and overhanging objects such as curtains or a shelf.
- **WARNING:** To avoid danger of suffocation please remove all packaging materials particularly plastic and EPS and keep these away from vulnerable people, children and babies.
- **NEVER** drop or insert any object or fingers into any openings.
- Do not cover or obstruct the air inlet and outlets.
- Do not use the appliance in locations where paint, petrol or other flammable liquids are used or stored.
- Do not use bug sprays or other flammable cleansers/vapour sprays on or around the unit.
- Always switch off the unit and take the plug out of the socket:
 - If you are not using the unit
 - Before you clean or carry out maintenance on the unit
 - If a fault occurs
 - In the event of an electrical storm.
- Avoid electromagnetic interference. Keep the unit at least 1 metre away from electrical appliances such as televisions & radios.
- The air conditioner must always be stored and transported upright. In case of doubt we suggest you wait for at least 24 hours before operation. (Please keep unit upright at all times).
- This portable air conditioner is fitted with a compressor delay protection circuit. This protects the unit from possible damage due to rapid starting and stopping of its compressor. The compressor will begin operating 3 minutes after the unit has been switched **ON** or if the mode is changed from dehumidify to cooling.
- It is hazardous for anyone other than an Authorised Service Person to service this appliance. In Queensland - the authorised Service Person **MUST** hold a Gas Work Authorisation for hydrocarbon refrigerants to carry out servicing or repairs where the gas system is being opened or charged.
- This appliance shall be installed in accordance with national wiring regulations.



WARNING: For using R290 refrigerant. This symbol shows that this appliance uses a flammable refrigerant. If the refrigerant is leaked and exposed to an external ignition source, there is a risk of fire.

CAUTION: RISK OF FIRE/FLAMMABLE MATERIALS. THE APPLIANCE MUST BE INSTALLED, USED & STORED IN AN AREA THAT IS GREATER THAN 7m².



NB: These symbols on your device mean:

- This appliance is filled with Propane gas R290. Follow strictly the manufacturer's instruction concerning use and repairs!
- Before using this appliance, you must carefully read the entire instruction manual.
- Do not install, operate or store the device in a room with a floor area smaller than 7m².
- Repairs must be performed based on the recommendations from the manufacturing company.
- Note also the information presented on the appliance.
- Do not use means to accelerate the defrosting process or to clean, other than those recommended by the manufacturer.
- The appliance shall NOT be stored in a room with continuously operating ignition sources (for example: open flames, an operating gas appliance or an operating electric heater).
- Do not pierce or burn.
- Be aware that the refrigerants may not contain an odour.
- The appliance should be installed, operated and stored in a room with a floor area according to the amount of refrigerant to be charged. For specific information on the type of gas and the amount, please refer to the relevant label on the unit itself. When there are differences between the label and the manual on the Min. room area description, the description on label shall prevail.
- Compliance with national gas regulations shall be observed.
- Keep ventilation openings clear of obstruction.
- The appliance shall be stored so as to prevent mechanical damage from occurring.
- A warning that the appliance shall be stored in a well-ventilated area where the room size corresponds to the room area as specified for operation.
- Any person who is involved with working on or breaking into a refrigerant circuit should hold a current valid certificate from an industry-accredited assessment authority, which authorises their competence to handle refrigerants safely in accordance with an industry recognised assessment specification.
- Servicing shall only be performed as recommended by the equipment manufacturer. Maintenance and repair requiring the assistance of other skilled personnel shall be carried out under the supervision of the person competent in the use of flammable refrigerants.

1. Transport of equipment containing flammable refrigerants - see transport regulations
2. Marking of equipment using signs - see local regulations
3. Disposal of equipment using flammable refrigerants - see national regulations.
4. Storage of equipment/appliances - The storage of equipment should be in accordance with the manufacturer's instructions.
5. Storage of packed (unsold) equipment - storage package protection should be constructed such that mechanical damage to the equipment inside the package will not cause a leak of the refrigerant charge. The maximum number of pieces of equipment permitted to be stored together will be determined by local regulations.
6. Information on servicing
 - **Checks to the area**

Prior to beginning work on systems containing flammable refrigerants, safety checks are necessary to ensure that the risk of ignition is minimised. For repair to the refrigerating system, the following precautions shall be complied with prior to conducting work on the system.
 - **Work procedure**

Work shall be undertaken under a controlled procedure so as to minimise the risk of a flammable gas or vapour being present while the work is being performed.
 - **General work area**

All maintenance staff and others working in the local area shall be instructed on the nature of work being carried out. Work in confined spaces shall be avoided. The area around the workspace shall be sectioned off. Ensure that the conditions within the area have been made safe by control of flammable material.
 - **Checking for presence of refrigerant**

The area shall be checked with an appropriate refrigerant detector prior to and during work, to ensure the technician is aware of potentially flammable atmospheres. Ensure that the leak detection equipment being used is suitable for use with flammable refrigerants, i.e. non-sparking, adequately sealed or intrinsically safe.
 - **Presence of fire extinguisher**

If any hot work is to be conducted on the refrigeration equipment or any associated parts, appropriate fire extinguishing equipment shall be available to hand. Have a dry powder or CO₂ fire extinguisher adjacent to the charging area.
 - **No ignition sources**

No person carrying out work in relation to a refrigeration system which involves exposing any pipe work that contains or has contained flammable refrigerant shall use any sources of ignition in such a manner that it may lead to the risk of fire or explosion. All possible ignition sources, including cigarette smoking, should be kept sufficiently far away from the site of installation, repairing, removing and disposal, during which flammable refrigerant can possibly be released to the surrounding space. Prior to work taking place, the area around the equipment is to be surveyed to make sure that there are no flammable hazards or ignition risks. No Smoking signs shall be displayed.
 - **Ventilated area**

Ensure that the area is in the open or that it is adequately ventilated before breaking into the system or conducting any hot work. A degree of ventilation shall continue during the period that the work is carried out. The ventilation should safely disperse any released refrigerant and preferably expel it externally into the atmosphere.

- **Checks to the refrigeration equipment**

Where electrical components are being changed, they shall be fit for the purpose and to the correct specification. At all times the manufacturer's maintenance and service guidelines shall be followed. If in doubt consult the manufacturer's technical department for assistance. The following checks shall be applied to installations using flammable refrigerants:

The charge size is in accordance with the room size within which the refrigerant containing parts are installed;

The ventilation machinery and outlets are operating adequately and are not obstructed;

If an indirect refrigerating circuit is being used, the secondary circuit shall be checked for the presence of refrigerant; Marking to the equipment continues to be visible and legible. Markings and signs that are illegible shall be corrected;

Refrigeration pipe or components are installed in a position where they are unlikely to be exposed to any substance which may corrode refrigerant containing components, unless the components are constructed of materials which are inherently resistant to being corroded or are suitably protected against being so corroded.

- **Checks to electrical devices**

Repair and maintenance to electrical components shall include initial safety checks and component inspection procedures. If a fault exists that could compromise safety, then no electrical supply shall be connected to the circuit until it is satisfactorily dealt with. If the fault cannot be corrected immediately but it is necessary to continue operation, an adequate temporary solution shall be used. This shall be reported to the owner of the equipment so all parties are advised. Initial safety checks shall include:

That capacitors are discharged: this shall be done in a safe manner to avoid possibility of sparking; That there no live electrical components and wiring are exposed while charging, recovering or purging the system; That there is continuity of earth bonding.

- **Repairs to sealed components**

During repairs to sealed components, all electrical supplies shall be disconnected from the equipment being worked upon prior to any removal of sealed covers, etc. If it is absolutely necessary to have an electrical supply to equipment during servicing, then a permanently operating form of leak detection shall be located at the most critical point to warn of a potentially hazardous situation.

Particular attention shall be paid to the following to ensure that by working on electrical components, the casing is not altered in such a way that the level of protection is affected. This shall include damage to cables, excessive number of connections, terminals not made to original specification, damage to seals, incorrect fitting of glands, etc. Ensure that apparatus is mounted securely. Ensure that seals or sealing materials have not degraded such that they no longer serve the purpose of preventing the ingress of flammable atmospheres. Replacement parts shall be in accordance with the manufacturer's specifications.

NOTE: The use of silicon sealant may inhibit the effectiveness of some types of leak detection equipment. Intrinsically safe components do not have to be isolated prior to working on them.

- **Repair to intrinsically safe components**

Do not apply any permanent inductive or capacitance loads to the circuit without ensuring that this will not exceed the permissible voltage and current permitted for the equipment in use. Intrinsically safe components are the only types that can be worked on while live in the presence of a flammable atmosphere. The test apparatus shall be at the correct rating. Replace components only with parts specified by the manufacturer. Other parts may result in the ignition of refrigerant in the atmosphere from a leak.

- **Cabling**

Check that cabling will not be subject to wear, corrosion, excessive pressure, vibration, sharp edges or any other adverse environmental effects. The check shall also take into account the effects of aging or continual vibration from sources such as compressors or fans.

- **Detection of flammable refrigerants**

Under no circumstances shall potential sources of ignition be used in the searching for or detection of refrigerant leaks. A halide torch (or any other detector using a naked flame) shall not be used.

- **Leak detection methods**

The following leak detection methods are deemed acceptable for systems containing flammable refrigerants. Electronic leak detectors shall be used to detect flammable refrigerants, but the sensitivity may not be adequate, or may need re-calibration. (Detection equipment shall be calibrated in a refrigerant-free area.) Ensure that the detector is not a potential source of ignition and is suitable for the refrigerant used. Leak detection equipment shall be set at a percentage of the LFL of the refrigerant and shall be calibrated to the refrigerant employed and the appropriate percentage of gas (25 %maximum) is confirmed. Leak detection fluids are suitable for use with most refrigerants but the use of detergents containing chlorine shall be avoided as the chlorine may react with the refrigerant and corrode the copper pipe-work. If a leak is suspected, all naked flames shall be removed/ extinguished. If a leakage of refrigerant is found which requires brazing, all of the refrigerant shall be recovered from the system, or isolated (by means of shut off valves) in a part of the system remote from the leak. Oxygen free nitrogen (OFN) shall then be purged through the system both before and during the brazing process.

- **Removal and evacuation**

When breaking into the refrigerant circuit to make repairs or for any other purpose conventional procedures shall be used. However, it is important that best practice is followed since flammability is a consideration. The following procedure shall be adhered to: Remove refrigerant; Purge the circuit with inert gas; Evacuate; Purge again with inert gas; Open the circuit by cutting or brazing. The refrigerant charge shall be recovered into the correct recovery cylinders. The system shall be flushed with OFN to render the unit safe. This process may need to be repeated several times. Compressed air or oxygen shall not be used for this task. Flushing shall be achieved by breaking the vacuum in the system with OFN and continuing to fill until the working pressure is achieved, then venting to atmosphere, and finally pulling down to a vacuum. This process shall be repeated until no refrigerant is within the system. When the final OFN charge is used, the system shall be vented down to atmospheric pressure to enable work to take place. This operation is absolutely vital if brazing operations on the pipe-work are to take place. Ensure that the outlet for the vacuum pump is not close to any ignition sources and there is ventilation available.

- **Charging procedures**

In addition to conventional charging procedures, the following requirements shall be followed. Ensure that contamination of different refrigerants does not occur when using charging equipment. Hoses or lines shall be as short as possible to minimise the amount of refrigerant contained in them.

Cylinders shall be kept upright.

Ensure that the refrigeration system is earthed prior to charging the system with refrigerant.

Label the system when charging is complete (if not already).

Extreme care shall be taken not to overfill the refrigeration system. Prior to recharging the system it shall be pressure tested with OFN. The system shall be leak tested on completion of charging but prior to commissioning. A follow up leak test shall be carried out prior to leaving the site.

- **Decommissioning**

Before carrying out this procedure, it is essential that the technician is completely familiar with the equipment and all its detail. It is recommended good practice that all refrigerants are recovered safely. Prior to the task being carried out, an oil and refrigerant sample shall be taken in case analysis is required prior to re-use of reclaimed refrigerant. It is essential that electrical power is available before the task is commenced.

a) Become familiar with the equipment and its operation.

b) Isolate system electrically.

c) Before attempting the procedure ensure that: Mechanical handling equipment is available, if required, for handling refrigerant cylinders; All personal protective equipment is available and being used correctly; The recovery process is supervised at all times by a competent person; Recovery equipment and cylinders conform to the appropriate standards.

d) Pump down refrigerant system, if possible.

e) If a vacuum is not possible, make a manifold so that refrigerant can be removed from various parts of the system.

f) Make sure that cylinder is situated on the scales before recovery takes place.

g) Start the recovery machine and operate in accordance with manufacturer's instructions.

h) Do not overfill cylinders. (No more than 80 % volume liquid charge).

i) Do not exceed the maximum working pressure of the cylinder, even temporarily.

j) When the cylinders have been filled correctly and the process completed, make sure that the cylinders and the equipment are removed from site promptly and all isolation valves on the equipment are closed off.

k) Recovered refrigerant shall not be charged into another refrigeration system unless it has been cleaned and checked.

- **Labelling**

Equipment shall be labelled stating that it has been de-commissioned and emptied of refrigerant. The label shall be dated and signed. Ensure that there are labels on the equipment stating the equipment contains flammable refrigerant.

- **Recovery**

When removing refrigerant from a system, either for servicing or decommissioning, it is recommended good practice that all refrigerants are removed safely. When transferring refrigerant into cylinders, ensure that only appropriate refrigerant recovery cylinders are employed. Ensure that the correct number of cylinders for holding the total system charge is available. All cylinders to be used are designated for the recovered refrigerant and labelled for that refrigerant (i.e. special cylinders for the recovery of refrigerant). Cylinders shall be complete with pressure relief valve and associated shut-off valves in good working order. Empty recovery cylinders are evacuated and, if possible, cooled before recovery occurs. The recovery equipment shall be in good working order with a set of instructions concerning the equipment that is at hand and shall be suitable for the recovery of flammable refrigerants. In addition, a set of calibrated weighing scales shall be available and in good working order. Hoses shall be complete with leak-free disconnect couplings and in good condition. Before using the recovery machine, check that it is in satisfactory working order, has been properly maintained and that any associated electrical components are sealed to prevent ignition in the event of a refrigerant release. Consult manufacturer if in doubt. The recovered refrigerant shall be returned to the refrigerant supplier in the correct recovery cylinder, and the relevant Waste Transfer Note arranged. Do not mix refrigerants in recovery units and especially not in cylinders. If compressors or compressor oils are to be removed, ensure that they have been evacuated to an acceptable level to make certain that flammable refrigerant does not remain within the lubricant. The evacuation process shall be carried out prior to returning the compressor to the suppliers. Only electric heating to the compressor body shall be employed to accelerate this process. When oil is drained from a system, it shall be carried out safely.

Specification

Model no.	DPRC20ECO-A
Rated voltage	220-240V~ 50Hz
Operating Temperature	16-32°C
Rated Power Input	780W
Cooling and Heating Capacity	2kW/1.7kW
Noise level	<53dB (A)
Product size (w x d x h)	315 x 310 x 698mm
Weight (gross)	23kg

- For greater precision, please always refer to the rating label placed on the product.

Features

- High Capacity in a compact size with fan, cooling, heating, and dehumidifying function.
- Temperature setting and display
- LED Digital display
- Electronic control with built-in timer, sleep mode
- Self-evaporating system for better efficiency
- Auto shut off when tank full
- Automatic restart in the event of power outage
- Auto defrosting function at low ambient temperatures
- Remote control
- 2-speed fan
- Casters for easy mobility

Parts

1. Control panel
2. Air outlet with adjustable louvre
3. Handle
4. Air inlet with air filter
5. Caster
6. Drainage Hole
7. Air Exhaust

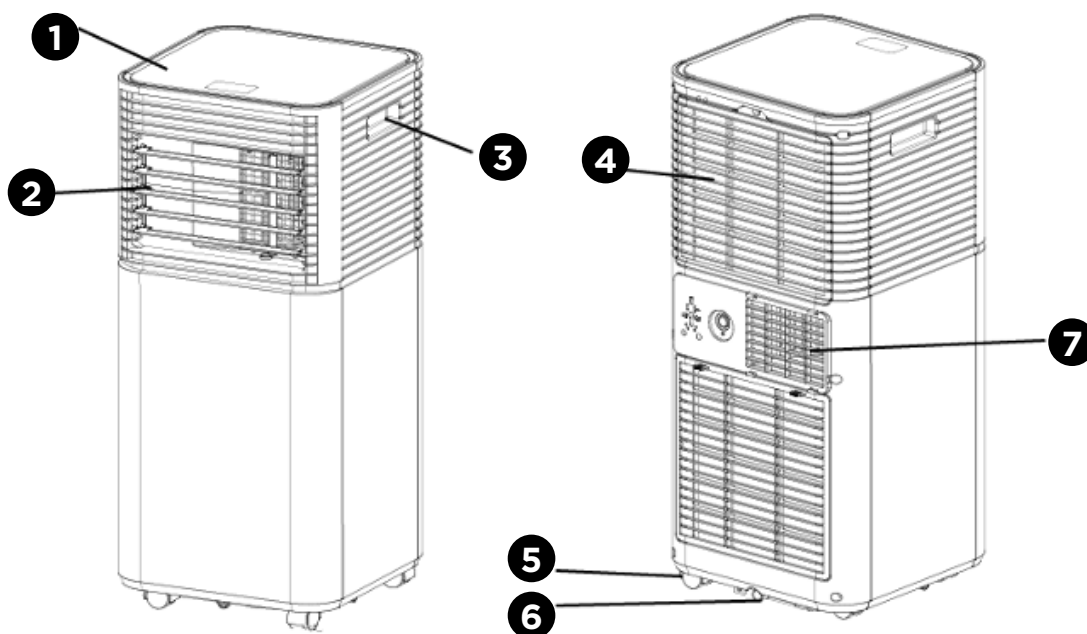

Note: The appearance is only for reference. Please see the real product for detailed information.

UNPACKING

Unpack the carton and take the appliance and accessories out. Check the device after unpacking for any damage or scratches on it.

Accessories:

1. Exhaust hose
2. Hose connector
3. Window kit adapter
4. Remote control
5. Drainage hose
6. Swing window kit

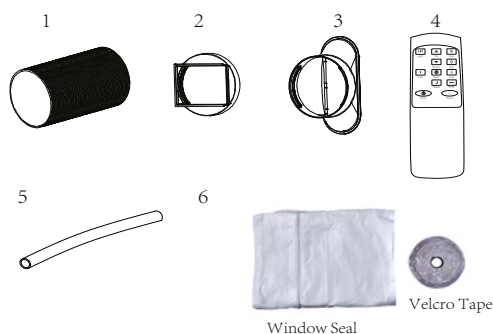

Installation Instructions

Note: All the illustrations in this manual are for explanatory purposes only. Your appliance may be slightly different. Be sure all accessories are removed from the packing before use.

CHOOSE YOUR LOCATION

- If tipped more than 45°, allow the unit to set upright for at least 24 hours before starting up.
- Place the unit on a firm, level surface in an area with at least 50cm of free space around it to allow for proper air circulation.
- Do not operate in close proximity to walls, curtains, or other objects that may block air inlet and outlet. Keep the air inlet and outlet free of obstacles.
- **Never** install the unit where it could be subject to:
 - Heat sources such as radiators, heat registers, stoves or other products that produce heat.
 - Direct sunlight
 - Mechanical vibration or shock
 - Excessive dust
 - Lack of ventilation, such as cabinet or bookcase
 - Uneven surface

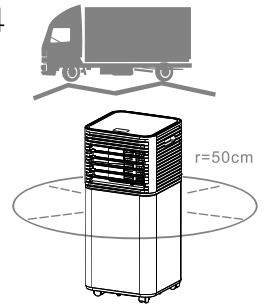

WARNING!

Install the unit in rooms which exceed 7 m².
Do not install the unit in a place where inflammable gas may leak.



NOTE!

The manufacture may provide other suitable example or may provide additional information about the refrigerant odour.

ATTACH THE EXHAUST HOSE

The air conditioner needs to be vented outside so that the exhaust air can escape the room (Exhaust air contains waste heat and moisture).

Do not replace or extend exhaust hose, this will result in decreased efficiency or even shut down the unit due to low backpressure.

Step 1: Connect the hose connector to one end of the exhaust hose.

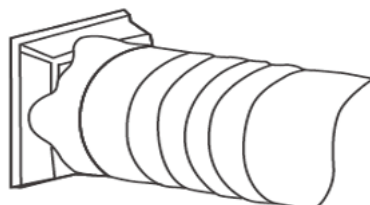

Step 2: Connect the windows kit adapter to the other end of the exhaust hose.

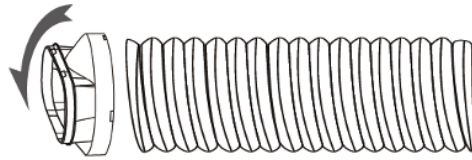

Step 3: Attach the hose connector to the exhaust air outlet of unit.

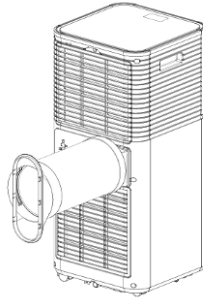

Step 4: Remove the backing tape and apply the Velcro tape to the non-hinged sides of your window and frame as shown below. Please ensure that the window can close properly with the Velcro tape applied.

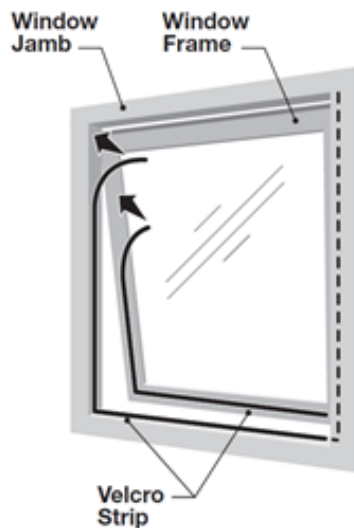

Step 5: Attach the window seal to the Velcro tape; ensure that there is no gap for the air to escape between the window frame and the window seal. The zip opening on the window seal must be located where the extendable hose outlet from the air conditioner can easily reach it. Open the zip to allow the outlet to be fitted and then close it tightly to hold the outlet in place.

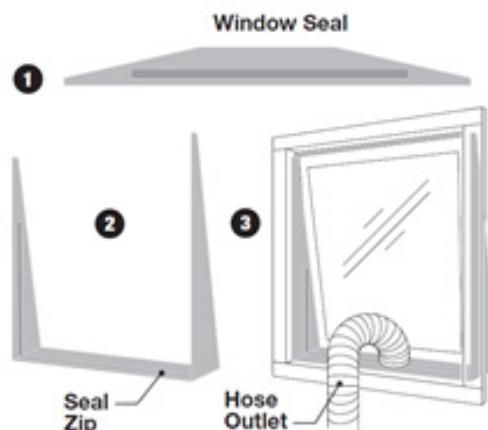

Step 6: To remove the window seal, simply remove the air conditioner outlet, then firmly pull on one end of a sealed section. You can then close your window as normal. The kit can be used on tilting or horizontal windows as shown.

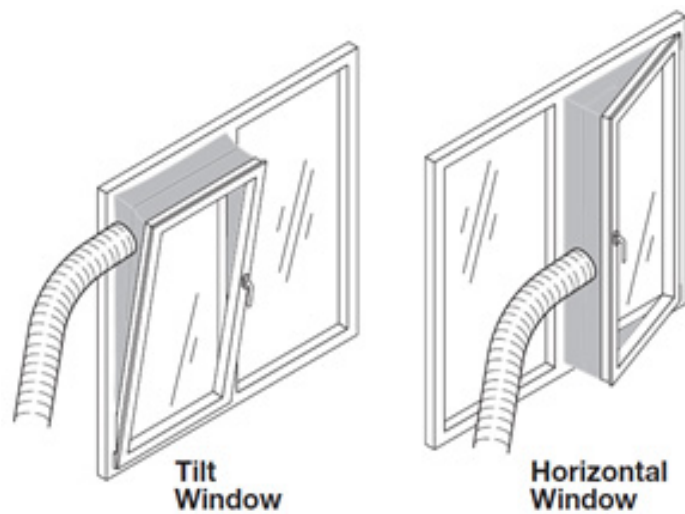

Step 7: Adjust the louver at the air outlet, and then switch on the unit.

Parts and Features

CONTROL PANEL

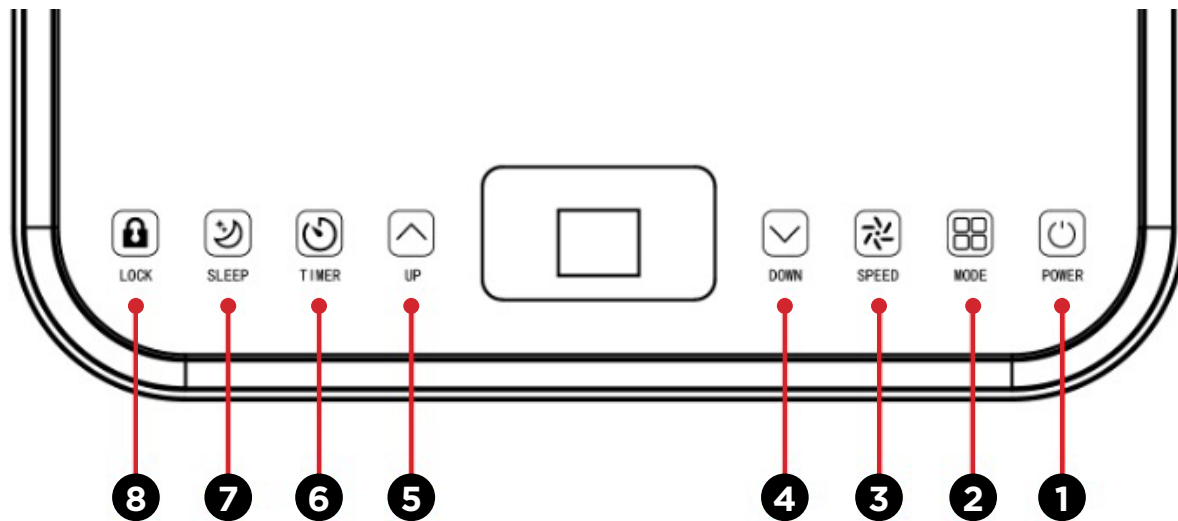

FUNCTION KEYS AND INDICATORS

1.	POWER	Press to switch the machine on or off.
2.	MODE	Press to switch the operation mode between fan, cooling, heating, and dehumidifier.
3.	Speed	Press to switch the fan speed between HIGH and LOW
4.	Down	Press to Decrease the desired temperature or timer setting.
5.	Up	Press to Increase the desired temperature or timer setting.
6.	TIMER	Press to set a time for the unit to automatically start or stop.
7.	SLEEP	Press to turn sleep mode on or off.
8.	Lock	Press to turn on or turn off the child lock function.

DISPLAY PANEL

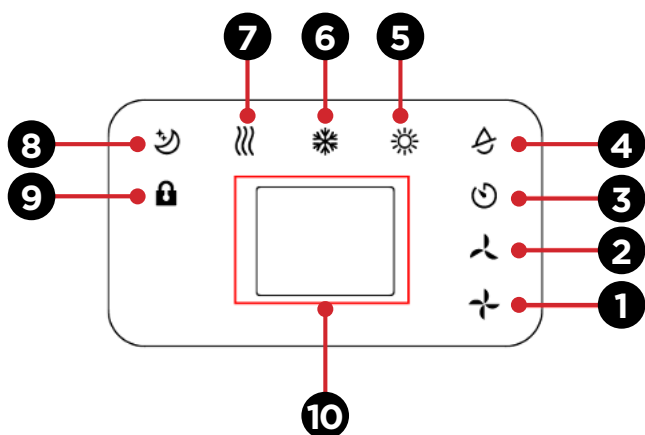

- 1. High Fan Speed
- 2. Low Fan Speed
- 3. Timer
- 4. Dehumidifier Mode
- 5. Heating Mode
- 6. Cooling Mode
- 7. Fan Mode
- 8. Sleep
- 9. Lock

REMOTE CONTROL

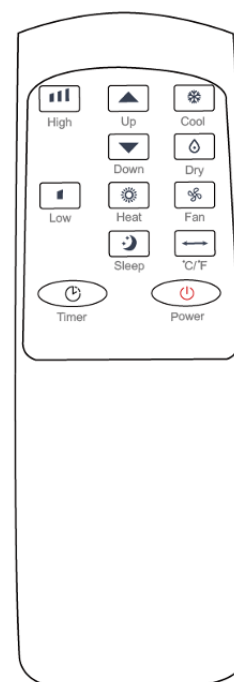

START-UP AND SHUTDOWN

- ⇒ Press POWER to turn the unit on.
The unit runs in FAN as default.
- ⇒ Press MODE button to select the desired operation mode.
- ⇒ Press POWER again to turn off the power.

OPERATION MODES

The unit has five operation modes: Cool, dry, fan, heat, sleep.

1. Cooling your room

Select the cool mode to lower the temperature in your room.

- ⇒ Press MODE button repeatedly until the LED of COOL operation lights up.
- ⇒ Press UP/DOWN button to adjust the temperature which is displayed on the screen. The temperature can be set between 16°C and 32°C.
- ⇒ Press SPEED button repeatedly until the desired fan speed indicator lights up.

To control the direction of the air flow horizontally, please adjust the inner louver by hand.

Note: The air conditioner stops if the room temperature is lower than selected temperature.

2. Heating your room (Optional for Heating Function Unit only)

- ⇒ Press MODE button repeatedly until the LED of HEAT operation lights up.
- ⇒ Press UP/DOWN button to set the temperature higher than the room temperature. The fan speed can also be set.

Note: The drainage hose should be attached to the unit for continuous operating.

3. Ventilating your room

- ⇒ Press MODE button repeatedly until the LED of FAN operation lights up.
In ventilation mode the room air is circulated, but not cooled.
- ⇒ Press SPEED button repeatedly to select the fan speed as desired.

4. Drying your room

- ⇒ Press MODE button on the control panel or remote control until the dry indicator lights up. The fan speed is unable to be adjusted during Drying operation. User should connect the hose to the drain outlet at the bottom of the unit.

Note: In this mode, the fan speed switches over to low speed and cannot be adjusted.

5. Sleep mode:

The sleep mode can be activated when in cool mode and heat mode.

• In cool mode:

After 1 hour the preset temperature is increased by 1°C, after another hour the preset temperature will again be increased by 1°C.

• In heat mode (Optional for Heating Function Unit only):

After 1 hour the preset temperature is decreased by 1°C, after another hour the preset temperature will again be decreased by 1°C.

The temperature will be kept constant for 10 hours and all the indicators will dim to dark. The fan speed may switch over to low speed for silent operating and cannot be adjusted.

TIMER SETTING (1-24 hours):

The timer has two methods of operation:

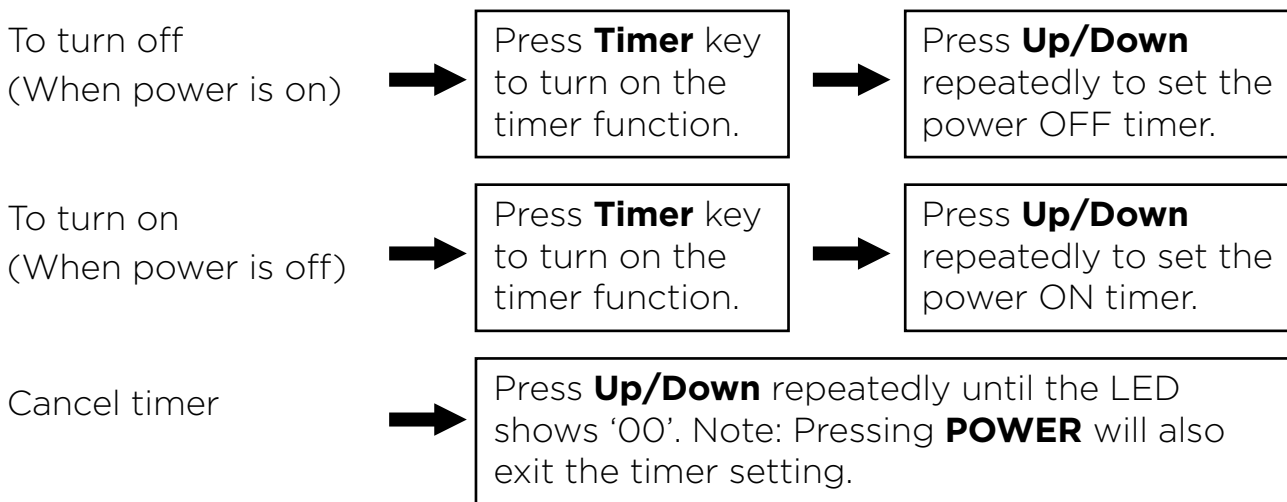

Automatic Defrost

At low room temperatures, frost may build up at the evaporator during operation. The unit will automatically start defrosting and the **POWER** LED will blink. The defrost control sequence is as follows:

- A. When the unit operates in the cooling operation or drying operation, and the ambient temperature sensor senses the evaporator coil temperature is below -1°C, then the compressor will stop operating for 10 minutes or until the coil temperature reaches 7°C, then the unit will restart the cooling operating mode.
- B. When the unit operates in the heating operation or drying operation, and the coil temperature sensor senses the temperature of the evaporator is below 40°C and the differential temperature between coil temperature and room temperature is below 19°C after the compressor has been operating for 20 minutes, the unit will start defrosting for 5 minutes and the power indicator will blink.

Overload Protection

In the event of power loss, to protect the compressor there is a 3-minute delay before the compressor restarts.

DRAINAGE

Self-evaporating system

The self-evaporating system uses the collected water to cool the condenser coils for more efficient performance. There is no need to empty the drainage tank in cooling operation, only in heating operation, drying operation, and high humidity conditions. The condensate water evaporates at the condenser and is expunged through the exhaust hose.

For continuous operation or unattended operating in drying and heating operation, please connect the attached drain hose to the unit. Condensate water can be automatically drained into a bucket or drain by gravity.

- Switch off the unit before operating.
- Remove the plug of the water outlet opening and keep it in safe area.
- Securely and properly connect the drain hose and make sure it is not kinked and clear of obstruction.
- Place the outlet of the hose over a drain or bucket and ensure that water can freely flow out of the unit.
- Do not submerge the end of hose into water; otherwise it can cause "Air Lock" in the hose.



To avoid water spillage:

- As the negative pressure of the condensate drain pan is large, tilt the drain hose downward towards the floor. It is appropriate that the degree of inclination should exceed 20 degrees.
- Straighten the hose to avoid any obstruction.

CLEANING THE AIR FILTER (every two weeks)

Dust collects on the filter and restricts the airflow. The restricted airflow reduces the efficiency of the system and if it becomes blocked it can cause damage to the unit.

The air filter requires regular cleaning. The air filter is removable for easy cleaning. Do not operate the unit without an air filter, or the evaporator may become contaminated.

1. Press POWER button to switch off the unit and unplug the power cord.
2. Remove the filter mesh from the unit.
3. Use a vacuum cleaner to suck dust from the filter.
4. Turn the filter over and rinse the air filter under running water. Let the water run through the filter in the opposite direction of air flow. Set aside and allow the filter to air dry completely before reinstalling.

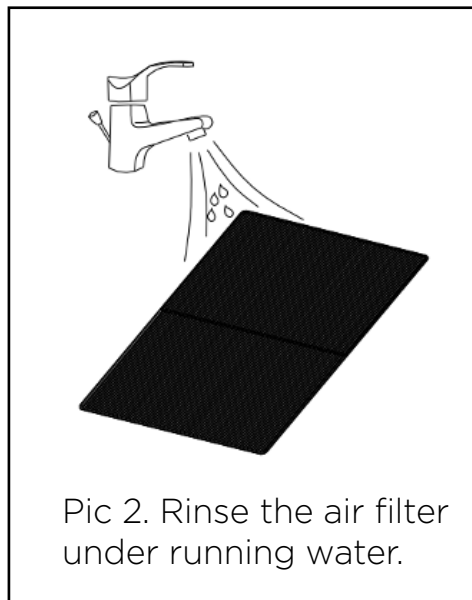
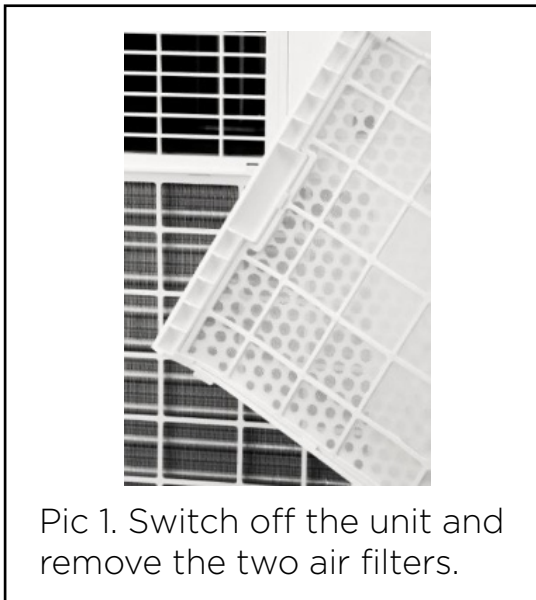

Warning!!!

Do not touch the evaporator surface with bare hands, or it could injure your fingers.

CLEANING UP OF REFRIGERANT

General Measures:

1. The Gas/vapor is heavier than air. May accumulate in confined spaces, particularly at or below ground level.
2. Eliminate every possible source of ignition.
3. Use appropriate personal protection equipment (PPE).
4. Evacuate unnecessary personnel, isolate, and ventilate area.
5. Do not get in eyes, on skin, or on clothing. Do not breathe vapors or gas.
6. Prevent entry to sewers and public waters.
7. Stop the source of the release, if safe to do so. Consider the use of water spray to disperse vapors.
8. Isolate the area until gas has dispersed. Ventilate and gas test area before entering. Contact competent authorities after a spill.

Troubleshooting

PROBLEM		CAUSE	SOLUTION
The unit is not operating.		<ul style="list-style-type: none"> • Check the power connection in securely. 	<ul style="list-style-type: none"> • Insert the power cord securely into the wall Outlet.
		<ul style="list-style-type: none"> • Check if the water level indicator lights up? 	<ul style="list-style-type: none"> • Empty the drain pan by remove the rubber plug.
		<ul style="list-style-type: none"> • Check the room temperature. 	<ul style="list-style-type: none"> • The range of operating temperature is 5-35°C.
The unit works with reduced capacity.		<ul style="list-style-type: none"> • Check the air filter for dirt. 	<ul style="list-style-type: none"> • Clean the air filter as necessary.
		<ul style="list-style-type: none"> • Check if the air duct is blocked. 	<ul style="list-style-type: none"> • To clear the obstacle.
		<ul style="list-style-type: none"> • Check if the room door or window is open. 	<ul style="list-style-type: none"> • Keep the door and windows closed.
		<ul style="list-style-type: none"> • Check if the desired operating mode is selected and the temperature is properly set. 	<ul style="list-style-type: none"> • Set the mode and temperature at proper set-point according the manual. (Refer to page 10).
		<ul style="list-style-type: none"> • The exhaust hose is detached. 	<ul style="list-style-type: none"> • Make sure the exhaust hose is securely attached.
Water Leakage		<ul style="list-style-type: none"> • Overflow while moving the unit. 	<ul style="list-style-type: none"> • Empty the water tank before transport.
		<ul style="list-style-type: none"> • Check if the drain hose is kinked or bends. 	<ul style="list-style-type: none"> • Straighten the hose to avoid a trap existing.
Excessive Noise		<ul style="list-style-type: none"> • Check if the unit is securely positioned. 	<ul style="list-style-type: none"> • Place the unit on horizontal and firm ground.
		<ul style="list-style-type: none"> • Check if any loose, vibrating parts. 	<ul style="list-style-type: none"> • Secure and tight the parts.
		<ul style="list-style-type: none"> • Noise sounds like water flowing. 	<ul style="list-style-type: none"> • Noise comes from flowing refrigerant. This is normal.
Error Codes	EO	<ul style="list-style-type: none"> • Communication faults between main PCB and display PCB. 	<ul style="list-style-type: none"> • Check the wire harness of the display PCB for damage.
	E1	<ul style="list-style-type: none"> • Ambient temperature sensor failure. 	<ul style="list-style-type: none"> • Check connection or replace it. To clean or replace the temperature sensor.
	E2	<ul style="list-style-type: none"> • Coil temperature sensor failures. 	<ul style="list-style-type: none"> • Check connection or replace it. To clean or replace the temperature sensor.
	Ft	<ul style="list-style-type: none"> • Condensate water high level alarm. 	<ul style="list-style-type: none"> • Empty the drain pan by removal the rubber plug.

STORAGE

Long-Term Storage - If you will not be using the unit for an extended period of time (more than a few weeks) it is best to clean the unit and dry it out completely. Please store the unit per the following steps:

1. Unplug the unit and remove exhaust hose and window kit store with the unit.
2. Drain the remaining water from the unit.
3. Clean the filter and let the filter dry completely in a shaded area.
4. Re-install the filter at its position.
5. The unit must be kept in upright position when in storage.
6. Preserving the machine in ventilating, dry, non- corrosive gas and safe place indoor.

ATTENTION:

The evaporator inside the machine has to be dried out before the unit is packed to avoid component damage and molds. Unplug the unit and place it in a dry open area for days to dry it out. Another way to dry the unit is turn on the machine, adjust it to low-wind ventilation mode, and maintain this state until the drainage pipe becomes dry, so as to keep the inside of the body in a dry state and prevent it from mildewing.

DISPOSAL



WARNING!!!

Releasing refrigerant into atmosphere is strictly forbidden!

Maintenance

If the unit fails to operate efficiently, is broken or other problems arise, unplug and do not operate. Ask for advice by calling your local after sales service agent or the Customer Care Centre on 1300 556 816 (AU)/ 0800 666 2824 (NZ).

Warranty

Please refer to the warranty card in the box for warranty information. For any troubleshooting advice, please contact the relative Customer Care Centre below.

Glen Dimplex Australia Pty Ltd

1340 Ferntree Gully Road,
Scoresby 3179, Victoria
Australia
Ph: 1300 556 816

Glen Dimplex New Zealand Ltd

38 Harris Road, East Tamaki,
Auckland 2013
New Zealand
Ph: 0800 666 2824



Recycling: Do not dispose of electrical appliances as unsorted municipal waste. Use separate collection facilities. Contact your local government for information regarding the collection systems available. If electrical appliances are disposed of in landfills or dumps, hazardous substances can leak into the ground water, polluting the food chain and damaging health and



Customer Care: 0800 666 2824
customer.care@glendimplex.co.nz
www.dimplex.co.nz

Supplied by Glen Dimplex New Zealand Ltd
38 Harris Road, East Tamaki, Auckland 2013

© Glen Dimplex New Zealand Ltd. All rights reserved. Material contained in this publication may not be reproduced in whole or in part, without prior permission in writing of Glen Dimplex New Zealand Ltd.

DPRC20ECO-A REV2