

CDimplex®

**10L DEHUMIDIFIER
WITH AIR PURIFICATION
INSTRUCTION MANUAL**

GDDEY10



PACKAGE CONTENTS

1 x Dehumidifier

1 x Instruction Manual

Confirm all parts before disposing of carton. Safely dispose of all plastic bags and other packaging components. They may be potentially dangerous to children.



IMPORTANT SAFETY INSTRUCTIONS

READ CAREFULLY AND KEEP FOR FUTURE REFERENCE

Carefully read this manual before using this appliance.

- Ensure that you know how the appliance functions and how to operate it.
- Maintain the appliance in accordance with the instructions to ensure that it functions properly.
- Keep this manual with the appliance. If the appliance is to be used by a third party, this instruction manual must be supplied with it.
- The safety instructions do not by themselves eliminate any danger completely and proper accident prevention measures must always be used.
- No liability can be accepted for any damage caused by non-compliance with these instructions or any other improper use or mishandling.

Do not use this appliance if it has been dropped or damaged in any way, or if the supply cord is damaged.

Intended Use

- Indoor domestic use only: this appliance is intended for indoor domestic use only. Do not use it outdoors. Do not use in moving vehicles or boats.
- Intended Purpose: Do not use the appliance for anything other than its intended purpose, and only use it as described in this manual
- Accessories: Do not use any accessories with the appliance that are not supplied or specifically recommended.

When using electric appliances always observe safety regulations where applicable to reduce the risk of fire, electric shock and personal injury.

Always check that the power supply corresponds to the voltage on the rating plate.

Supply Cord and Plug

Always unplug from mains supply when not in use. Do not abuse or damage the power cord. If the supply cord is damaged, it must be replaced by the manufacturer or its service agent or a similarly qualified person in order to avoid a hazard. Do not turn this Dehumidifier on or off by inserting or removing the plug from a switched on power outlet and always pull out the plug from the socket (pull on the plug, not the cable)

Earth Safety

This appliance must be earthed. Only connect to a suitably earthed 220-240V ~ 50Hz supply socket.

Use and Environment

Operate the Dehumidifier on a flat and stable surface. The appliance must be operated the right way up. Do not tip over. Do not use outdoors. Do not operate the dehumidifier in a closed area such as inside a closet, as it may cause a fire.

Do not touch the upper lid of the air outlet. Do not touch the air outlet opening. Never put your fingers or objects into the intake or discharge ducts.

Do not put the unit close to heat-generating devices or near flammable and dangerous materials.

Install drain piping at a downhill grade to make sure that condensed water can be drained continuously.

Do not run the cord under carpeting and do not cover cord with throw rugs, runners or the like. Arrange cord away from traffic area and where it will not be tripped over.

Avoid the use of an extension cord as this may overheat and cause a risk of fire.

Do not insert or allow objects to enter any ventilation or exhaust opening. To prevent a possible fire, do not block air intakes or exhaust openings in any manner.

This Dehumidifier is filled with a precise quantity of R134a refrigerant; repairs are only to be made by the manufacturer or service agent who should be contacted if there is a refrigerant leakage.

When scrapping the Dehumidifier, follow the regulations concerning the disposal of refrigerant.

Supervision

This appliance is not intended for use by persons (including children) with reduced physical, sensory or mental capabilities, or lack of experience and knowledge, unless they have been given supervision or instruction concerning use of the appliance by a person responsible for their safety. Children should be supervised to ensure that they do not play with the appliance.

Damaged or Dropped

Always inspect your appliance before use. Check parts are correctly attached. Do not use this appliance if it has been damaged, dropped, left outdoors or dropped in water. Return it to an authorised service dealer for examination and repair.

Water

Do not immerse the appliance or its supply cord in water. Do not use with wet hands or use in damp situations. Do not use near a bath, shower or swimming pool.

Cleaning

Do not try to clean the inner part of the air inlet or outlet with a sharp object. Do not spray the dehumidifier with water, pesticide or flammable liquid.

Do not use Dehumidifier in any other orientation other than upright as shown in this manual.

The unit should be installed with a minimum distance of 20 cm from all walls or other obstacles.

TECHNICAL SPECIFICATIONS

Model	GDDEY10
Operating Voltage	220V-240V~50Hz
Dehumidification Capacity	10L/DAY
Rated Power	400W
Net Weight	9.5KG
Refrigerant	R134a
Noise Level	42dB(A)
Operating Temperature	Between 5-32 degrees celcius
Dimensions	217mmw x 416mmh x 296mmh

ASSEMBLY AND PARTS

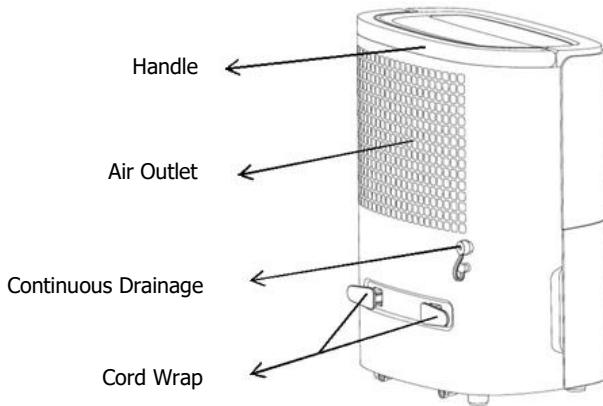
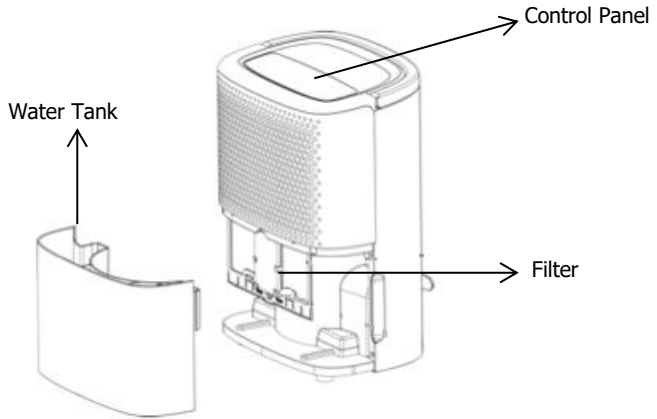

Control Panel

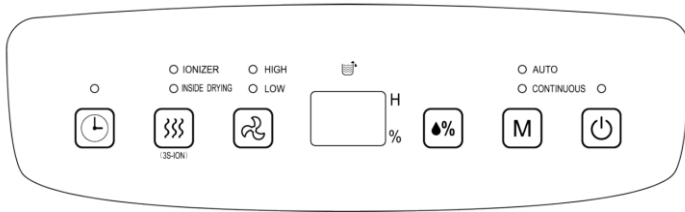

Timer: 24 hour timer, press the button to set the timer. Timer range is from 1 to 24 hours, and will increase by 1 hour with each press. Press the button again to cancel the timer.

Inside drying: Press the  button to dry within the unit. This is useful for preventing build up of mould and mildew. Drying can take up to one hour.

Ionizer function: To activate anionic purification, press and hold  button for three seconds. To turn off press and hold for another three seconds.

Fan: Press fan speed button to set the desired fan speed. It can be adjusted between high speed and low speed.

Display screen: In auto dehumidifying or continuous mode, display screen will indicate the actual room humidity. (In timer mode it indicates the timer setting.)

Humidity setting: In auto dehumidifying mode (not continuous) press the  key to set humidity level, humidity range is from 30% to 80%, and increases 5% each press.

Mode: When device is on press  button to choose auto-dehumidifying or continuous dehumidifying (Laundry mode). The lights will flash when mode is changed.

On/Off: Press the power key to turn on/turn off the unit.

Clearance

Maintain the minimum clearance around the dehumidifier when the unit is operating as shown below.



INSTRUCTIONS

Using Your Dehumidifier

Timer on/off:

When the Dehumidifier is turned on, press the timer button to program the time you wish the unit to turn off. Pressing the timer button will change the timer by 1 hour increments (up to 24). The unit will automatically switch off after the pre-selected time. After timer is set the timer button flashes 5 times for confirmation. To turn off the timer, press the timer button again.

Auto dehumidifying mode:

Press the humidity set button to select the desired humidity level in the room, this can be set from 30% to 80% at 5% intervals.

After a period of operation, once environment humidity is lower than the selected humidity by 5%, the compressor will stop and the fan will continue as per original setting.

When the environment humidity is equal to or higher than the selected humidity by 5%, the compressor will restart once the 3-minute compressor protection time is over. If room humidity > setting humidity +5%, compressor will start and fan will operate. If room humidity < setting humidity -5%, compressor will stop and fan will operate according to the original setting.

NOTE: The initial humidity value is set to 50%.

Continuous mode

Selecting this mode will make the unit will work regardless of the room humidity. The compressor will work and fan speed is adjustable.

Water Tank Full

When the drainage tank is full, the tank full indicator light will turn on, the operation will stop automatically and the buzzer will beep 10 times to alert the user that the water needs to be emptied from the drainage tank.

Emptying the Drainage Tank

1. Lightly press on the sides of the tank with both hands and pull the tank out gently.

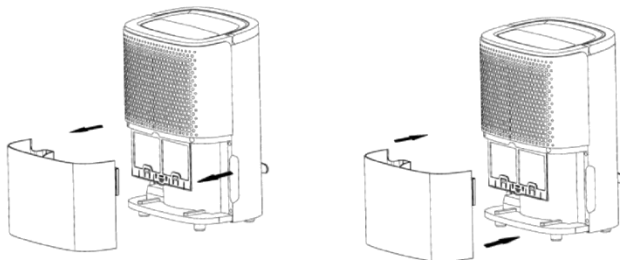

2. Discard the collected water



NOTE

1. Do not remove the float from the water tank. The water full sensor will no longer be able to detect the water level correctly without the float and water may leak from the water tank.

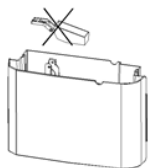

2. If the drainage tank is dirty, wash it with cold or lukewarm water. Do not use detergent, scouring pads, chemically treated dust cloths, gasoline, benzene, thinner, or other solvents, as these can scratch and damage the tank and cause water leakage.
3. When replacing the drainage tank, press the tank firmly into place with both hands. If the tank is not positioned properly, the "TANK FULL" sensor will be activated, and the dehumidifier will not operate.

Continuous Water Drainage

The unit features a continuous drainage port. Using a plastic pipe (with an inner diameter of 9mm) insert it into drain hole and arrange the drain pipe accordingly so that gravity pulls the water out (there is no pump mechanism).

The water in the drainage tank can be continuously drained out from the port on the unit.

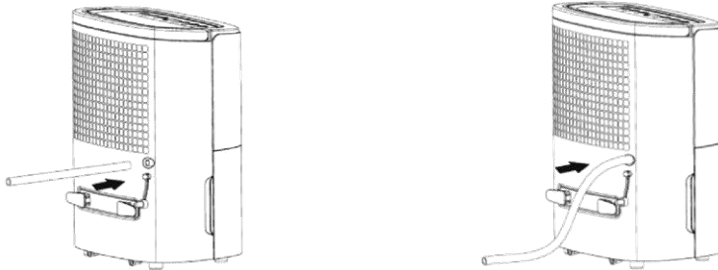

Note: Water pipe cannot be too long (usually +0.6m) as this may cause water leakage.

CLEANING and MAINTENANCE

This appliance requires little maintenance. It contains no user-serviceable parts. Any servicing requiring disassembly other than cleaning must be performed by a qualified appliance repair technician.

Before Cleaning

- Before unplugging unit ensure all controls are set to off.
- When not in use or before cleaning, always disconnect the appliance from the mains supply.

Care and Cleaning

- Accumulated dust may be removed from dehumidifier surfaces with a soft cloth.
- For more thorough cleaning, use a cloth that has been moistened with a solution of mild detergent and water.
- Dry the dehumidifier casing thoroughly with a soft, dry cloth before operating the unit again.

To Clean the Air Filter (every two weeks)

1. Open the inlet grill and remove the air filter

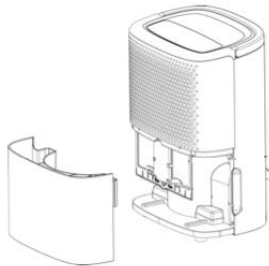

2. Clean the air filter

Run a vacuum cleaner lightly over the surface of the air filter to remove dirt. If the air filter is exceptionally dirty, wash it with warm water and a mild cleanser and dry thoroughly.

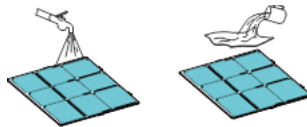

3. Re-attach the air filter
4. The carbon and formaldehyde filter fits into the middle of the airfilter



Storing the Dehumidifier

When not in use store your appliance and any of its accessories and instruction manual in a safe and dry place.

1. Empty any water left in the drainage tank.
2. Fold up the power supply cord and put it in the water tank.
3. Clean the air filter.
4. Store in a cool and dry place.

NOTICE: Never use rough scouring pads or abrasive cleansers on any plastic or metal parts as the surface may be damaged.

TROUBLESHOOTING

If a condition listed below occurs, please check the following items before calling customer service.

Problem	Possible Cause	Solution
The unit doesn't operate	Has the power cord been disconnected?	Plug the power cord into the outlet.
	Is the tank full indication lamp blinking? (The tank is full or in a wrong position.)	Empty the water in the drainage tank and then reposition the tank.
	Is the temperature of the room above 32°C or below 5°C?	The protection device is activated and the unit cannot be started. Place the unit in an area within the temperature limits.
The dehumidifying function doesn't work	Is the air filter clogged?	Clean the air filter as instructed under "Cleaning and Maintenance".
	Is the intake duct or discharge duct obstructed?	Remove the obstruction from the discharge duct or intake duct.
No air is discharged	Is the air filter clogged?	Clean the air filter as instructed under "Cleaning and Maintenance".
Operation is overly noisy	Is the unit tilted or unsteady?	Move the unit to a stable, flat location. Please note some noise is to be expected and it normal for a unit of this type
	Is the air filter clogged?	Clean the air filter as instructed under "Cleaning and Maintenance".



Glen Dimplex New Zealand Ltd
 38 Harris Road, East Tamaki
 Auckland, New Zealand
 P.O. Box 58473, Botany
 Manukau 2163, New Zealand

Phone: 09 274 8265
 Fax: 09 274 8472
 Email: sales@glendimplex.co.nz
 Web: www.dimplex.co.nz