

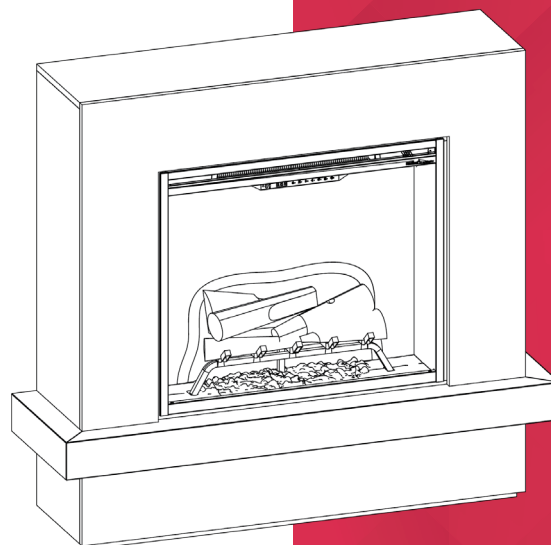

INSTRUCTION MANUAL

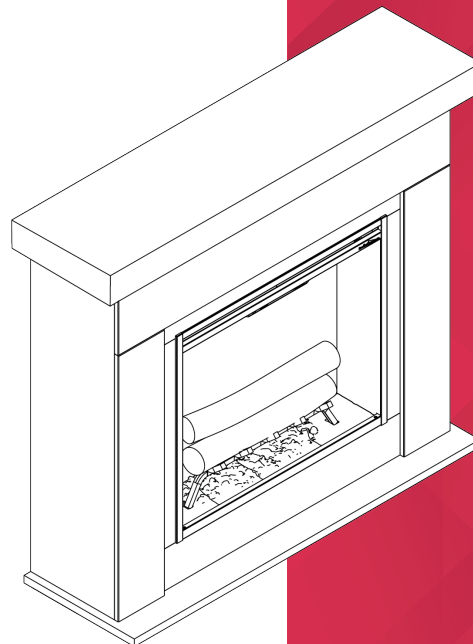

Huxley & Sherwood 2kW Revillusion Suites

Model: SWD20-AU, HXY20-AU

For domestic household use only.



IMPORTANT

THESE INSTRUCTIONS SHOULD BE READ CAREFULLY AND RETAINED FOR FUTURE REFERENCE.

CAUTION: FAILURE TO FOLLOW THESE INSTRUCTIONS MAY CAUSE INJURY AND/OR DAMAGE AND MAY INVALIDATE YOUR WARRANTY

Please read the operating instructions carefully before using your product for the first time and keep them in a safe place.

- When using electrical appliances, basic precautions should always be followed to reduce the risk of fire, electrical shock and injury to persons, including the following:
- If the appliance is damaged, check with the supplier before installation and operation.
 - Do not use outdoors.
 - Do not use in the immediate surroundings of a bath, shower or a swimming pool.
 - Do not use this heater if it has been dropped.
 - Do not use if there are visible signs of damage to the heater.
 - Use this heater on a horizontal and stable surface, or fix it to the wall, as applicable.
- Do not locate the appliance immediately below a fixed socket outlet or connection box.
- This appliance is not intended for use by persons (including children) with reduced physical, sensory or mental capabilities, or lack of experience and knowledge, unless they have been given supervision or instruction concerning use of the appliance by a person responsible for their safety.
- Children should be supervised to ensure that they do not play with the appliance.
- Do not use this appliance in series with a thermal control, a program controller, a timer or any other device that switches on the heat automatically, since a fire risk exists when the appliance is accidentally covered or dis-placed.
- In the event of a fault, unplug the appliance.
- Unplug the appliance when not required for long periods.
- This product is only intended for **INDOOR RESIDENTIAL** applications only.
- **DO NOT** cover cord with carpeting, throw rugs, runners, or similar coverings.
- **DO NOT** route cord under furniture or appliances. Take care to position the cord away from traffic areas and where it will not be a tripping hazard.
- This appliance must not be used in a bathroom.

- Although this appliance complies with safety standards, we do not recommend its use on deep pile carpets or on long hair type of rugs
- The appliance must be positioned so that the plug is accessible.
- If the supply cord is damaged it must be replaced by the manufacturer or service agent or a similarly qualified person in order to avoid a hazard.
- Keep the supply cord away from the front of the appliance.
- Do not use this heater in small rooms when they are occupied by persons not capable of leaving the room on their own, unless constant supervision is provided.
- To reduce the risk of fire, keep textiles, curtains and or flammable material a minimum distance of 1m from the air outlet.
- In order to avoid overheating, **DO NOT COVER** the appliance. Do not place material or garments on the appliance, or obstruct the air circulation around the appliance, for instance by curtains or furniture, as this could cause overheating and a fire risk.
-  This Heater carries the warning symbol indicating that it must not be covered.
- In order to avoid a hazard due to inadvertent resetting of the thermal cut-out, this appliance must not be supplied through an external switching device, such as a timer, or connected to a circuit that is regularly switched on and off by the utility.
- **CAUTION** Some parts of this product can become very hot and cause burns. Particular attention has to be given where children and vulnerable people are present.
- Children shall not turn on/off the appliance.
- Ensure that furniture, curtains or other combustible material are positioned no closer than 1 metre from the appliance.
- Unplug the appliance when not required for long periods.
- Keep the supply cord away from the front of the appliance.
- This product is only suitable for well insulated rooms or occasional use.

WARNING: KEEP BATTERIES OUT OF REACH OF CHILDREN

- Swallowing may lead to serious injury in as little as 2 hours or death, due to chemical burns and potential perforation of the oesophagus.
- If you suspect your child has swallowed or inserted a button battery immediately call the 24-hour Poisons Information Centre on 13 11 26 (in Australia) or 0800 764 766 (in New Zealand) for fast, expert advice.
- Examine devices and make sure the battery compartment is correctly secured, e.g. that the screw or other mechanical fastener is tightened. Do not use if the compartment is not secure.
- Dispose of used button batteries immediately and safely. Flat batteries can still be dangerous.

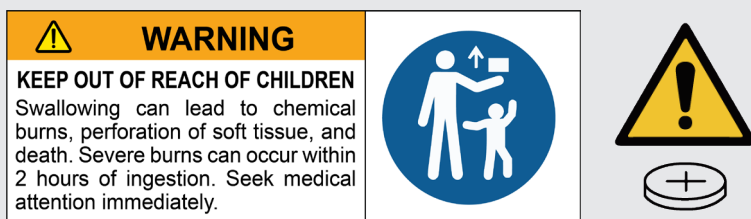

CAUTION: No obvious symptoms

Unfortunately, it is not obvious when a button or coin battery is stuck in a child's oesophagus (food pipe).

There are no specific symptoms associated with this. The child might:

- cough, gag or drool a lot
- appear to have a stomach upset or virus
- be sick
- point to their throat or stomach
- have a pain in their abdomen, chest or throat
- be tired or lethargic
- be quieter or more clingy than usual or otherwise 'not themselves'
- lose their appetite or have a reduced appetite
- not want to eat solid food/be unable to eat solid food

These types of symptoms vary or fluctuate, with the pain increasing and then subsiding.

A specific symptom to button and coin battery ingestion is vomiting fresh (bright red) blood. If the child does this seek immediate help. The lack of clear symptoms is why it is important to be vigilant with 'flat' or spare button or coin batteries in the home and the products that contain them.

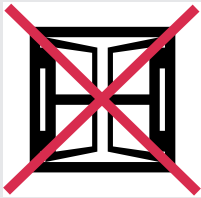

Exposed to the weather outdoors



Near water

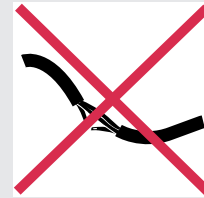

If the power cable wires are frayed or cut



Where small children may be left unattended

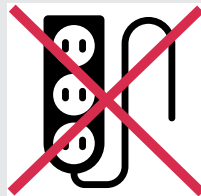

No extension leads or power boards



Where the power cable may be damaged



On a slope or uneven surface



Where there is risk of fire or close to a naked flame



Where it may be damaged by chemicals



Where there is a risk of interference by foreign objects



This product is not made for DIY repair



If there is a risk of water falling on the unit

Specifications

Model no.	SWD20-AU	HXY20-AU
Colour/Finish	White	
Wattage	2000	
Heat Settings	1	
Thermostat Control	Y	
Remote Control	Y	
Warranty	2 years	
Dimensions (w x d x h)	1380 x 415 x 1245	1400 x 415 x 1225

For greater precision, please always refer to the rating label placed on the product.

Product Dimensions

Sherwood

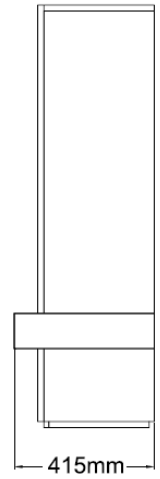
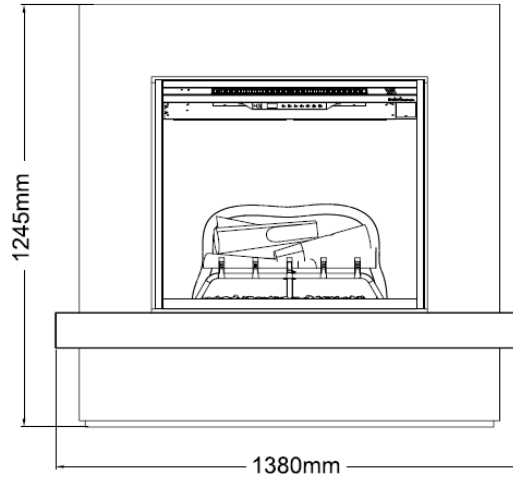
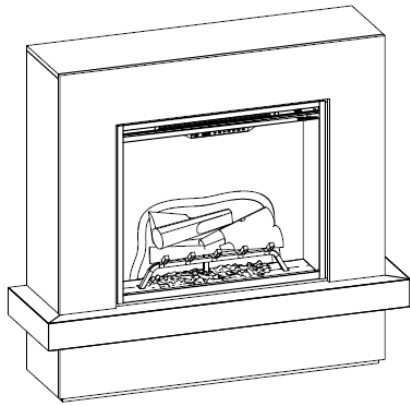

Huxley

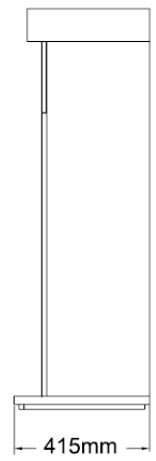
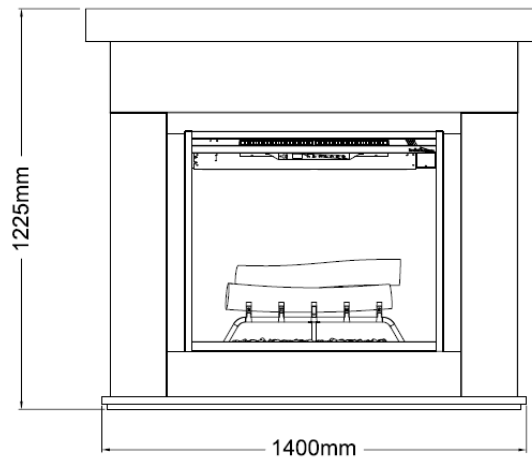
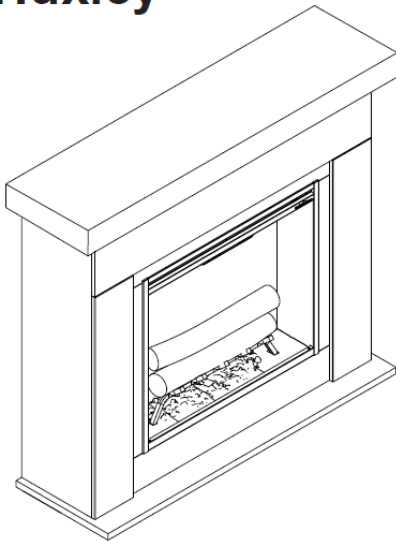

Operating Temperature

-20°-40°C

Fixed Wiring

In some jurisdictions this appliance is supplied without a plug. This is to comply with local regulations. In such instances, this appliance must be installed by a suitably qualified installer and the means for disconnection must be incorporated in the fixed wiring in accordance to the local wiring rules.

WARNING: Electrical outlet wiring must comply with local building codes and other applicable regulations to reduce the risk of fire, electric shock or injury.

Note: A 10 Amp circuit is required. A dedicated circuit is preferred, but not essential in all cases. A dedicated circuit will be required if, after installation, the circuit breaker trips or the fuse blows on a regular basis when the heater is operating. Additional appliances on the same circuit may exceed the current rating of the circuit breaker.

Unpacking the Unit

The unit comes packed with a protective sheet covering the front of the unit. This sheet is intended to prevent dust and debris from entering during construction. This sheet is designed so that it can be partially removed to complete the wiring and unpacking and can be reinstalled until the final installation is complete.

The log set was installed on the grate and the grate permanently fixed to the firebox at the factory.

Carefully remove the packaging from around the log set. Make sure the wires from the log set are connected securely to the grate box.

CAUTION: The Realogs contain LEDs to create a unique pulse and glow effect. Handle the log set carefully. They are fragile and can crack or break if dropped.

WARNING: FALLING OR TIPPING APPLIANCES CAN CAUSE INJURY OR DEATH OF YOUNG CHILDREN, PLEASE ENSURE CHILDREN DO NOT CLIMB, HANG OR STAND ON THIS PRODUCT.

⚠ WARNING: THIS APPLIANCE IS PROVIDED WITH A TIPPING RESTRAINT. THIS RESTRAINT IS NOT A SUBSTITUTE FOR PROPER ADULT SUPERVISION. THIS RESTRAINT MAY PROVIDE PROTECTION AGAINST TIPPING FURNITURE. DO NOT ALLOW CHILDREN TO CLIMB ON FURNITURE. FAILURE TO DETACH THIS RESTRAINT BEFORE MOVING FURNITURE MAY RESULT IN INJURY AND DAMAGE.

Tipping Restraint Kit

This product is provided with a 'Tipping Restraint Kit,' to prevent the product accidentally tipping over. Fitting instructions are supplied with this kit. Please follow these instructions carefully.

Thermal Safety Cut-out

A thermal safety cut-out is incorporated in the fan heater to prevent damage due to overheating. This can happen if the heat outlet was restricted in any way. If the cut-out operates, unplug the heater from the socket outlet and allow approximately 10 minutes before reconnecting. Before switching the heater back on remove any obstruction that may be restricting the heat outlet, then continue normal operation.

WARNING: In order to avoid a hazard due to inadvertent resetting of the thermal cut-out, this appliance must not be supplied through an external switching device, such as a timer, or connected to a circuit that is regularly switched on and off by the utility.

Tipping restraint kit

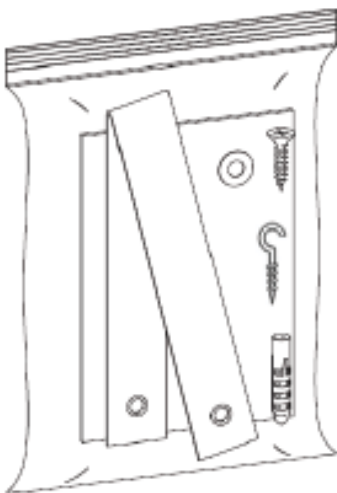

Control Panel & Remote

WARNING: FAILURE TO FOLLOW THESE OPERATING INSTRUCTIONS MAY RESULT IN INJURY AND/OR DAMAGE.

WARNING: The Revillusion Built-in Electric Firebox must be installed properly before usage.

CAUTION: Except for installation and cleaning described in the manual, an authorised service representative should perform any other servicing.

The manual controls for the Revillusion Built-in Electric Firebox are located on the front panel. Touch an icon to activate. The selected setting displays on the left side of the panel.

Remote control

The maximum range of use is ~ 9 metres.

WARNING: It takes time for the receiver to respond to the transmitter. Do not press the buttons more than once within two seconds for correct operation.

NOTE: The receiver for the remote control is located in the display, aim the remote control in this direction when inputting demands.

1. To activate the remote control remove the battery isolation strip, which is used to ensure your remote control reaches you fully charged.
2. To replace the remote control battery, turn over the remote control, and follow the diagram embossed on the remote control
3. Only use CR2032 size batteries.

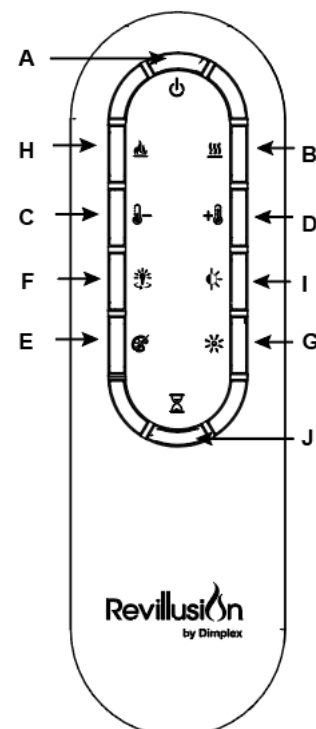
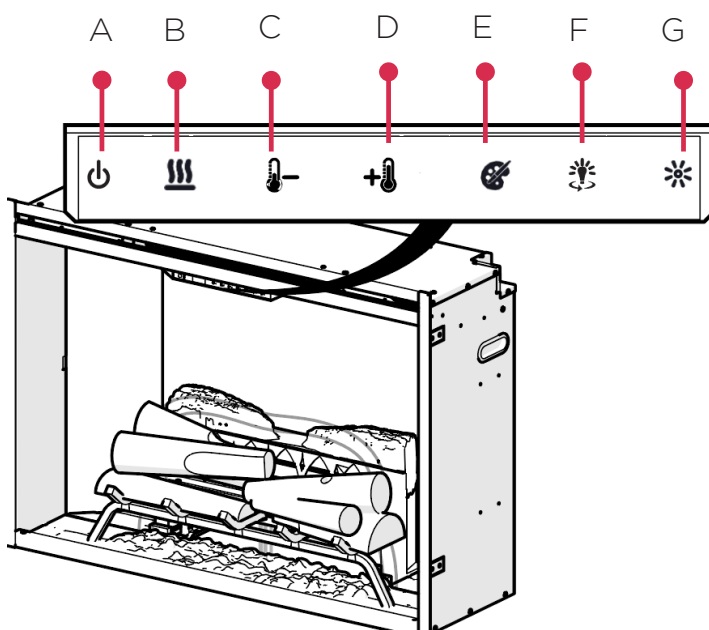

Control Panel & Remote

To replace the battery:

1. Remove the screw, push down on the battery cover located on the back side of the remote control. Slide the battery cover open.
2. Install 3V (CR2032) Lithium battery in the battery holder. The positive side (+) of the battery faces up.
3. Close the battery cover and replace the screw.





Discard leaking batteries:

Dispose of batteries in the proper manner according to provincial and local regulations. Any battery may leak electrolyte if mixed with a different battery type, if inserted incorrectly, if all batteries are not replaced at the same time, if disposed on a fire, or if an attempt is made to change a battery not intended to be recharged.

Operating Instructions

	Icon	Function	Description
A		Power/Standby	Press to turn the unit on or put it in Standby mode. When the unit is turned back on, it will retain the previously used settings (except timer).
B		Heat	<p>Heat On Press to turn heat On (indicated by 1 short beep and the icon appearing on the display). The display will show the current heater temperature setting. Use the Temp Up/Down icon to change the heater temperature setting.</p> <p>Heat Off Press to turn heat Off (indicated by 1 short beep).</p> <p>Note: After the heater is switched off, the fan will continue on for 60 seconds before turning off.</p>
C		Temperature Down	Press multiple times to lower the heater temperature in 1°F (1°C) increments. The display will show the current temperature; the lowest temperature is 41°F (5°C). This feature is active whenever the heat is enabled.
D		Temperature Up	Press multiple times to raise the heater temperature in 1°F (1°C) increments. The display will show the current temperature; the highest temperature is 99°F (37°C). This feature is active whenever the heat is enabled.
Change Fahrenheit (°F) to Celsius (°C)			Press both Temp+ (+) and Temp- (-) on the unit.
Heat Enable Heat Disable			<ul style="list-style-type: none"> Hold both Heat () and Temp- (-) on the unit for 2 seconds. Temperature displays on the screen. Hold both Heat () and Temp- (-) on the unit for 2 seconds. When the temperature is adjusted "---" displays on the screen.
E		Colour Themes	Press multiple times to change the flame base colours from Red-Blue-Off (The first segment on the display will change from "r" to "b" to blank). This feature is active only when the flame effect is on.
F		360° Light	Press multiple times to change the LEDs on the sides and back of the unit from Midnight mode to white to yellow to red (the middle segment on the display will change through 0-3 respectively). This feature is only active when flame is ON.
G		Brightness	Press to change the LED lights from High to Low (the last segment on the display will change from "H" to "L"). The Realog LEDs remain On when the heater is ON and the flame effect is OFF. Note: When the light sensor is activated, High and Low flickering brightness settings are also available (flashing "H" and "L").
H		Flame	Press to light the log set and start the flame effect. Press again to turn this feature off.
I		Light Sensor	Press to activate (ALS ON) the ambient light sensor. Press again to turn the sensor OFF (ALS OFF). Note: The light sensor will adjust the brightness of the fireplace based on the ambient light in the room.
J		Timer	Press multiple times to change the sleeper timer in 0.5 hour increments from 0.5 to 8 hours before turning off. The remaining time on the sleep timer displays.
Control Lock Control Unlock			<ul style="list-style-type: none"> Hold both Temp- (-) and brightness () on the unit for 2 seconds to disable the manual controls. Hold both Temp- (-) and Brightness () on the unit for 2 seconds to enable the manual controls.

User Modes:

Mode Name /Description	Action (Actions cannot be input by remote control)
Change Celsius (° C) to Fahrenheit (° F)	Press both Temp down () and Temp up () on the unit and hold until beep is heard and display flashes. (To revert back to Celsius repeat this action)
Disable/Enable Heat Options	Hold both Flame cycle () and Heat cycle (), on the product, for 5 seconds, when the heater has been disabled the product will beep. This will disable heat control functions on the product only. To enable heat repeat this action. Note: the remote control will still be able to operate heat functions.

Maintenance

Inspect the built-in firebox regularly depending on conditions and at a minimum, yearly intervals. Remove dust and clean the logs, grate and base as required.

WARNING: Disconnect power and allow heater to cool before attempting any maintenance or cleaning to reduce the risk of fire, electric shock or injury.

CAUTION: Except for installation and cleaning described in this manual, an authorized service representative should perform any other servicing.

Clean Logs and Base

The built-in electric firebox set should not be operated with an accumulation of dust or dirt on or in the firebox, as this can cause a build up of heat and eventual damage. Dust and vacuum the firebox as needed. Use a damp cloth and a mild detergent to clean painted surfaces of the built-in electric firebox. Never use abrasive cleaners.

Clean Reflector Screen

The reflector screen is cleaned in the factory during the assembly operation. During shipment, installation, handling etc., the screen may collect dust particles. These can be removed by dusting lightly with a clean dry cloth.

To remove fingerprints or other marks, clean the reflector screen with a damp cloth. Never use abrasive cleaners. Dry the screen completely with a lint free cloth to prevent water spots.

Warranty

Please refer to the warranty card in the box for warranty information. For any troubleshooting advice, please contact the relative Customer Care Centre below.

Glen Dimplex Australia Pty Ltd

8 Lakeview Drive,
Scoresby 3179, Victoria
Australia
Ph: 1300 556 816

Glen Dimplex New Zealand Ltd

38 Harris Road, East Tamaki,
Auckland 2013
New Zealand
Ph: 0800 666 2824



Recycling: Do not dispose of electrical appliances as unsorted municipal waste. Use separate collection facilities. Contact your local government for information regarding the collection systems available. If electrical appliances are disposed of in landfills or dumps, hazardous substances can leak into the ground water, polluting the food chain and damaging health and well-being.



Customer Care: 1300 556 816
customer.care@glendimplex.com.au
www.dimplex.com.au

Supplied by Glen Dimplex Australia
8 Lakeview Drive, Scoresby, Victoria, 3179

© Glen Dimplex Australia. All rights reserved. Material contained in this publication may not be reproduced in whole or in part, without prior permission in writing of Glen Dimplex Australia.