

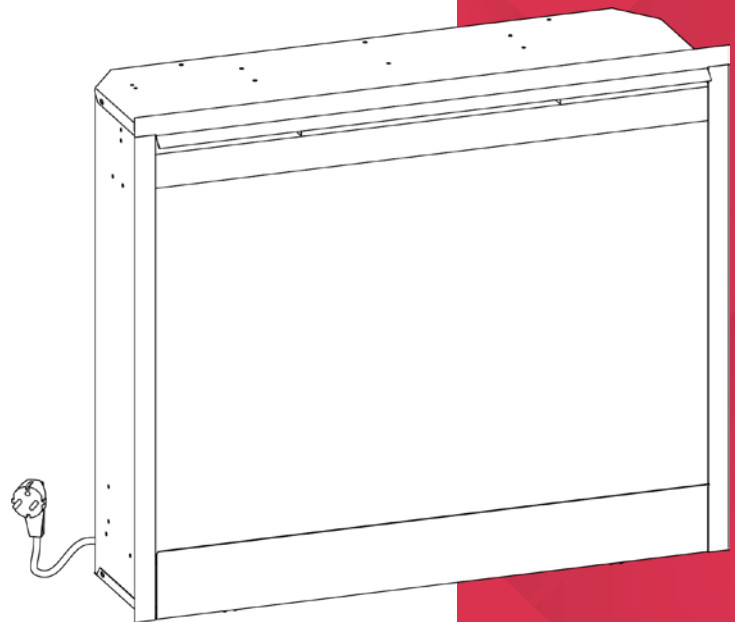

INSTRUCTION MANUAL



Optiflame 26'' Firebox

Model: DF2608-LED

For domestic household use only.



IMPORTANT

THESE INSTRUCTIONS SHOULD BE READ CAREFULLY AND RETAINED FOR FUTURE REFERENCE.

CAUTION: FAILURE TO FOLLOW THESE INSTRUCTIONS MAY CAUSE INJURY AND/OR DAMAGE AND MAY INVALIDATE YOUR WARRANTY

Please read the operating instructions carefully before using your product for the first time and keep them in a safe place.

- When using electrical appliances, basic precautions should always be followed to reduce the risk of fire, electrical shock and injury to persons, including the following:
- If the appliance is damaged, check with the supplier before installation and operation.
 - Do not use outdoors.
 - Do not use in the immediate surroundings of a bath, shower or a swimming pool.
 - Do not use this heater if it has been dropped.
 - Do not use if there are visible signs of damage to the heater.
 - Use this heater on a horizontal and stable surface, or fix it to the wall, as applicable.
- Do not locate the appliance immediately below a fixed socket outlet or connection box.
- This appliance is not intended for use by persons (including children) with reduced physical, sensory or mental capabilities, or lack of experience and knowledge, unless they have been given supervision or instruction concerning use of the appliance by a person responsible for their safety.
- Children should be supervised to ensure that they do not play with the appliance.
- Do not use this appliance in series with a thermal control, a program controller, a timer or any other device that switches on the heat automatically, since a fire risk exists when the appliance is accidentally covered or dis-placed.
- In the event of a fault, unplug the appliance.
- Unplug the appliance when not required for long periods.
- This product is only intended for **INDOOR RESIDENTIAL** applications only.
- **DO NOT** cover cord with carpeting, throw rugs, runners, or similar coverings.
- **DO NOT** route cord under furniture or appliances. Take care to position the cord away from traffic areas and where it will not be a tripping hazard.
- This appliance must not be used in a bathroom.

- Although this appliance complies with safety standards, we do not recommend its use on deep pile carpets or on long hair type of rugs
- The appliance must be positioned so that the plug is accessible.
- If the supply cord is damaged it must be replaced by the manufacturer or service agent or a similarly qualified person in order to avoid a hazard.
- Keep the supply cord away from the front of the appliance.
- Do not use this heater in small rooms when they are occupied by persons not capable of leaving the room on their own, unless constant supervision is provided.
- To reduce the risk of fire, keep textiles, curtains and or flammable material a minimum distance of 1m from the air outlet.
- In order to avoid overheating, **DO NOT COVER** the appliance. Do not place material or garments on the appliance, or obstruct the air circulation around the appliance, for instance by curtains or furniture, as this could cause overheating and a fire risk.
-  This Heater carries the warning symbol indicating that it must not be covered.
- In order to avoid a hazard due to inadvertent resetting of the thermal cut-out, this appliance must not be supplied through an external switching device, such as a timer, or connected to a circuit that is regularly switched on and off by the utility.
- **CAUTION** Some parts of this product can become very hot and cause burns. Particular attention has to be given where children and vulnerable people are present.
- Children shall not turn on/off the appliance.
- Ensure that furniture, curtains or other combustible material are positioned no closer than 1 metre from the appliance.
- Unplug the appliance when not required for long periods.
- Keep the supply cord away from the front of the appliance.
- This product is only suitable for well insulated rooms or occasional use.

WARNING: KEEP BATTERIES OUT OF REACH OF CHILDREN

- Swallowing may lead to serious injury in as little as 2 hours or death, due to chemical burns and potential perforation of the oesophagus.
- If you suspect your child has swallowed or inserted a button battery immediately call the 24-hour Poisons Information Centre on 13 11 26 (in Australia) or 0800 764 766 (in New Zealand) for fast, expert advice.
- Examine devices and make sure the battery compartment is correctly secured, e.g. that the screw or other mechanical fastener is tightened. Do not use if the compartment is not secure.
- Dispose of used button batteries immediately and safely. Flat batteries can still be dangerous.

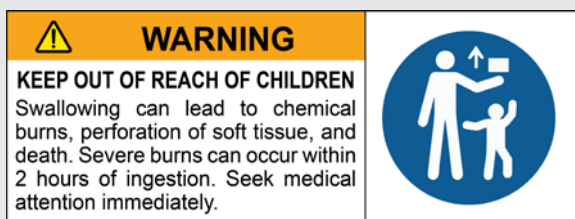

CAUTION: No obvious symptoms

Unfortunately, it is not obvious when a button or coin battery is stuck in a child's oesophagus (food pipe).

There are no specific symptoms associated with this. The child might:

- cough, gag or drool a lot
- appear to have a stomach upset or virus
- be sick
- point to their throat or stomach
- have a pain in their abdomen, chest or throat
- be tired or lethargic
- be quieter or more clingy than usual or otherwise 'not themselves'
- lose their appetite or have a reduced appetite
- not want to eat solid food/be unable to eat solid food

These types of symptoms vary or fluctuate, with the pain increasing and then subsiding.

A specific symptom to button and coin battery ingestion is vomiting fresh (bright red) blood. If the child does this seek immediate help. The lack of clear symptoms is why it is important to be vigilant with 'flat' or spare button or coin batteries in the home and the products that contain them.



Exposed to the weather outdoors



Near water



If the power cable wires are frayed or cut



Where small children may be left unattended

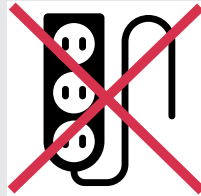

No extension leads or power boards



Where the power cable may be damaged



On a slope or uneven surface



Where there is risk of fire or close to a naked flame



Where it may be damaged by chemicals



Where there is a risk of interference by foreign objects



This product is not made for DIY repair



If there is a risk of water falling on the unit

Specifications

Model no.	DF2608-LED
Colour/Finish	Black
Wattage	2000
Heat Settings	2
Thermostat Control	Yes
Remote Control	Yes
Warranty	2 Years
Dimensions (w x d x h)	695w x 222d x 575h

For greater precision, please always refer to the rating label placed on the product.

Product Dimensions

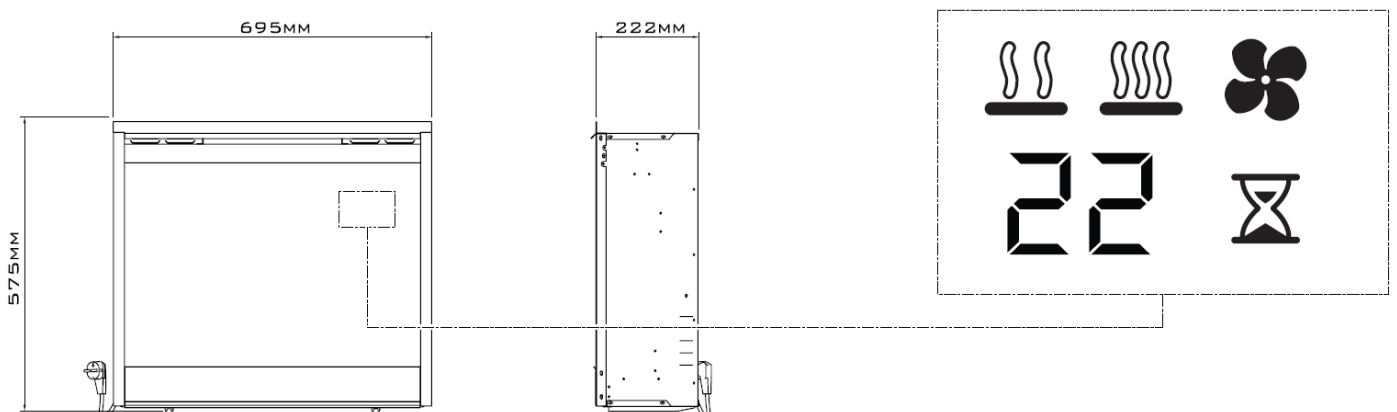

General Information

The fire incorporates a flame effect, which can be used with or without heat, so that the comforting effect may be enjoyed at any time of the year.

To reduce heat loss and to prevent any chimney up draft affecting the operation of your stove fire, we recommend that the chimney flue is sealed off. Always ensure that the appliance is sitting on a level surface.

Before connecting the appliance, check that the supply voltage is the same as that stated on the appliance.

Please note: Used in an environment where background noise is very low, it may be possible to hear a sound which is related to the operation of the fan heater & flame effect. This is normal and should not be a cause for concern.

Electrical Connection

⚠ WARNING: THIS APPLIANCE MUST BE EARTHED

This heater must be used on an AC ~ supply only and the voltage marked on the heater must correspond to the supply voltage. Before switching on, please read the safety warnings at the start of the instruction manual and operating instructions to follow. Please retain this user's guide for future reference

If you settle this appliance in an existing chimney space, we recommend that;

1. You have your chimney cleaned by a competent chimney sweep.
2. You block off the chimney flue.

This procedure is important for the efficient operation of the heating unit and will also reduce heat loss up the chimney.

Ensure that all packing items are removed (read any warning labels carefully). Retain all packing for possible future use e.g. in the event of moving or returning the appliance to your supplier.

Light Emitting Diode

This fire is fitted with LED (Light Emitting Diode) bulbs in place of traditional incandescent bulbs. These generate the same light levels as traditional bulbs, but use a fraction of the energy consumed. These LED lamps are maintenance free and should not require replacing during the life of the product.

Thermal Safety Cut-out

A thermal safety cut-out is incorporated in the fan heater to prevent damage due to overheating. This can happen if the heat outlet was restricted in any way. If the cut-out operates, unplug the heater from the socket outlet and allow approximately 10 minutes before reconnecting. Before switching the heater back on remove any obstruction that may be restricting the heat outlet, then continue normal operation.

WARNING: In order to avoid a hazard due to inadvertent resetting of the thermal cut-out, this appliance must not be supplied through an external switching device, such as a timer, or connected to a circuit that is regularly switched on and off by the utility.

INSTALLING FRONT GLASS

NOTE: The outer glass is shipped separate to the firebox.

1. Remove the 6 screws holding the side trims and remove the metal trims.

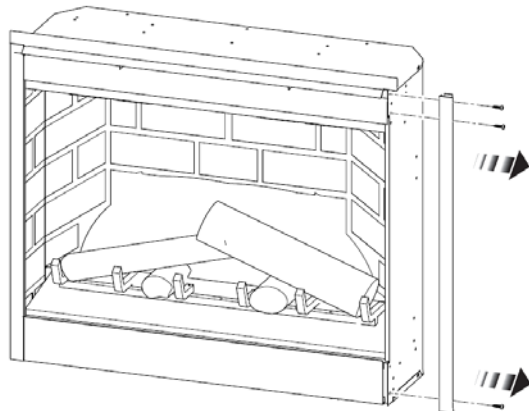

2. Unpack the glass, ensure it is free from dust and finger marks and place into position.

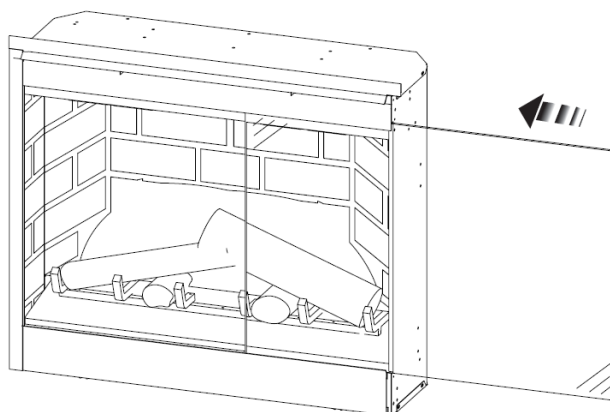

3. Position the metal trims removed in step 1, and secure with the 6 screws.

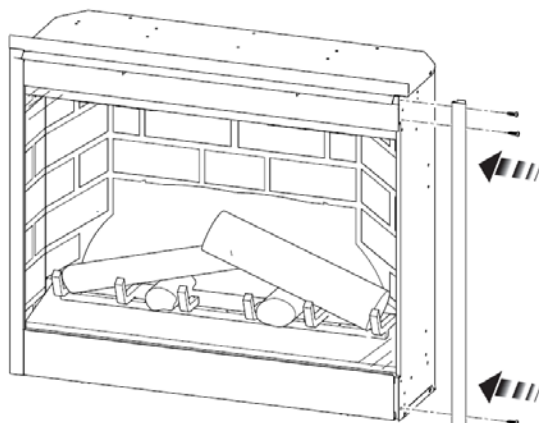

FITTING

IMPORTANT: If not using a Dimplex mantel, the fireplace must be installed in an enclosure with the following MINIMUM dimensions.

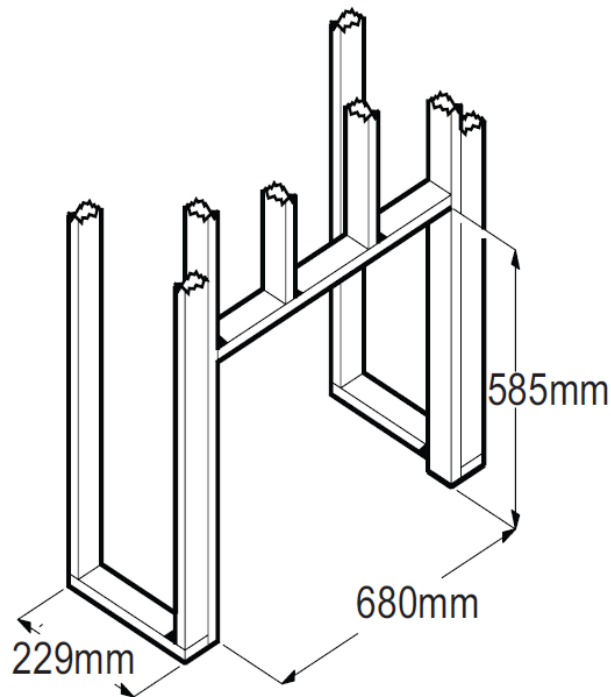

1. Select a suitable location that is not susceptible to moisture and is at least 1 meter away from drapes, furniture and high traffic.
2. Store the fireplace in a safe, dry and dust free location.
3. Clearance for air circulation beneath the fireplace is provided by two spacers. **DO NOT** install the fireplace directly on carpet or similar surfaces which may restrict air circulation. If installing the fireplace in a carpeted area, place a one-piece, solid flat surface under the fireplace. Ensure that all feet rest securely on this surface.
4. In some jurisdictions this appliance is supplied without a plug. This is to comply with the local regulations. In such instances, this appliance must be installed by a suitably qualified installer and the means for disconnection must be incorporated in the fixed wiring in accordance with the local wiring rules.

NEW WALL CONSTRUCTION

1. Select a suitable location that is not susceptible to moisture and is away from drapes, furniture and high traffic.
2. Place the fireplace in the desired location to see how it will look in the room.
3. Mark the desired location on the floor.
4. Use studs to frame an opening of 680mm wide X 585mm high X 229mm deep.

Option 1

The power cord can be run from behind the trim and along the wall to an outlet near the fireplace.

Option 2

A new outlet can be installed inside the framing construction. Plug the fireplace into a 10-13Amp/230-240 volt outlet. If the cord does not reach you may use a 3-core type extension cord rated for a minimum of 10 Amps.

EXISTING FIREPLACE

1. Seal all drafts and vents with a non-fibrous insulation material to prevent any chimney debris from falling onto the fireplace. Do not install into an existing fireplace that is prone to dampness.
2. Cap the top of the chimney flue to prevent rain from entering.
3. Plan your electric power supply.
4. The power cord can run along the front of the hearth to an outlet near the fireplace.

Control Panel & Remote

WARNING: FAILURE TO FOLLOW THESE OPERATING INSTRUCTIONS MAY RESULT IN INJURY AND/OR DAMAGE.

Remote control

The maximum range of use is ~ 5 metres.

WARNING: It takes time for the receiver to respond to the transmitter. Do not press the buttons more than once within two seconds for correct operation.

NOTE: The receiver for the remote control is located in the display, aim the remote control in this direction when inputting demands.

1. To activate the remote control remove the battery isolation strip, which is used to ensure your remote control reaches you fully charged.
2. To replace the remote control battery, turn over the remote control, and follow the diagram embossed on the remote control
3. Only use CR2025 or CR2032 size batteries.

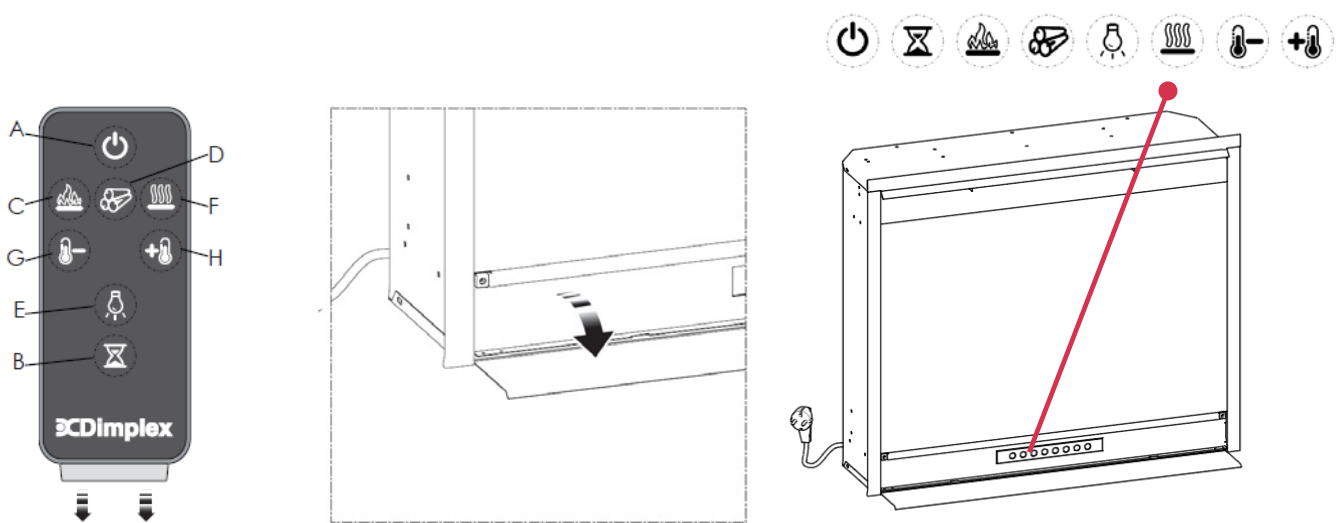











To replace the battery:

1. Remove the screw, push down on the battery cover located on the back of the remote control. Slide the battery cover open.
2. Install 1 x 3V CR2025 or CR2032 Lithium battery in the battery holder. The positive (+) side of the battery faces up.
3. Close the battery cover and replace the screw



Discard leaking batteries:

Dispose of batteries in the proper manner according to provincial and local regulations. Any battery may leak electrolyte if mixed with a different battery type, if inserted incorrectly, if all batteries are not replaced at the same time, if disposed on a fire, or if an attempt is made to change a battery not intended to be recharged.





Operating Instructions

		Dis- play	Func- tion	Description
A		-	Power / Standby	Press Once to turn the product 'ON'. Press a second time to put the product into 'STANDBY'. (When returning from 'STANDBY' mode the product will return to previous settings unless the product has been unplugged, in which case it will reset to factory settings)
B			Sleep Timer	Press multiple times to change the 'SLEEP TIMER' in 0.5 hr increments from 0.5 hr to 8.0 hr before turning off. The remaining time on the 'SLEEP TIMER' displays. (This icon is Green in colour)
C		Flame Effect		'FLAME EFFECT' button cycles the unit sequentially through the 4 settings. LOW FLAME, HIGH FLAME, DEMO MODE and OFF.
		F1 / F2 / FP		'FLAME EFFECT' Button This button will change the brightness of the flame effect. There are 3 brightness settings shown as F1, F2, FP. F1 will run the flame effect at a low brightness level (The display will show F1). F2 will run the flame effect at a high brightness setting (The display will show F2). FP will slowly pulse the flame effect between low and high brightness (The display will show FP).
		-	Off	This will turn the flame effect off. If the heater is running, the display will activate and remain active to read the set temperature and show if the product is on LOW HEAT/HIGH HEAT/COOL BLOW.
D		Log Effect		'LOG EFFECT' button cycles the unit sequentially through the 3 settings, 'PULSING LOGS', 'STATIC LOGS', 'COOL BLOW', and 'OFF.'
		LP	Pulsing Logs	This setting will make the logs pulse. (The display will show FP).
		LS	Static logs	This setting will make the logs stay lit. (The display will show FS).
		-	Off	This setting will turn the logs off.
E		-	On / Off	This button cycles the top light 'on' and 'Off'
F				'HEAT' button cycles the unit sequentially through the 4 settings: LOW HEAT, HIGH HEAT, COOL BLOW and OFF. The heat setting will be indicated by an icon in the display. When the flame effect is 'ON' the display will turn off after 5 seconds, however if the heater is being used independently of the flame effect. The low heat or high heat icon will appear continuously in the display.
			Low Heat	This setting will run the heater at 'LOW HEAT' this setting will be indicated by the 'LOW HEAT' icon and the letters 'LO' appearing in the display. To adjust the temperature setting the Temp Down or Temp Up buttons described below must be used. (This icon is Orange in Colour)
			High Heat	This icon in the display indicates 'HIGH HEAT' this setting will be indicated by the 'HIGH HEAT' icon and the letters 'HI' appearing in the display. To Adjust the temperature setting the Temp Down or Temp Up buttons described below must be used. (This icon is Red in Colour)
			Cool Blow	This icon in the floating display indicates 'COOL BLOW' this setting will be indicated by the 'COOL BLOW' icon and the letters 'CB' appearing in the display. (This icon is Blue in Colour)
		-	Off	This switches the heater and blower 'OFF', no icon will be displayed in the display. Note the blower will run for 10-20 seconds after being turned off, this is to ensure the product cools down safely.

Operation

G		31	Temp Up	<p>Press multiple times to increase the heater temperature in 1°C increments. The highest temperature that can be set 37°C.</p> <p>Note: Once you stop at your desired temperature this will flash 3 times, then the display will show the room temperature as detected by the product. If the set temperature is lower than the detected room temperature the heater will not activate.</p>
H		18	Temp Down	<p>Press multiple times to lower the heater temperature in 1°C increments. The lowest temperature that can be set is 5°C.</p> <p>Note: Once you stop at your desired temperature this will flash 3 times, then the display will show the room temperature as detected by the product. If the set temperature is lower than the detected room temperature the heater will not activate.</p>

User Modes:

Mode Name /Description	Action (Actions cannot be input by remote control)
Change Celsius (° C) to Fahrenheit (° F)	Press both Temp down () and Temp up () on the unit and hold until beep is heard and display flashes. (To revert back to Celsius repeat this action)
Disable/Enable Heat Options	Hold both Flame cycle () and Heat cycle (), on the product, for 5 seconds, when the heater has been disabled the product will beep. This will disable heat control functions on the product only. To enable heat repeat this action. Note: the remote control will still be able to operate heat functions.

Cleaning

Over time, dust can accumulate which can effect performance. It is recommended to clean the unit at least once a month.

CAUTION: ALWAYS Turn the unit **OFF** and disconnect the appliance from the power supply before undergoing any cleaning and maintenance.

The surfaces of the heater should be given an occasional wipe with a dry soft cloth. **Do not** use detergents, abrasive cleaning powder or furniture polish as this can damage the surface of the product.

The glass door should be cleaned carefully with a chamois leather. **Do not** use proprietary cleaners.

To remove any accumulation of dust or fluff, the soft brush attachment of a vacuum cleaner should occasionally be used to clean the outlet grille of the fan heater located under the stoves main body.

To clean the fuel effect, remove the ash/crystal and wash in warm water. The plastic tray should be wiped clean with a damp cloth. When completely dry replace the ash/crystal and arrange as described in this manual.

Warranty

Please refer to the warranty card in the box for warranty information. For any troubleshooting advice, please contact the relative Customer Care Centre below.

Glen Dimplex Australia Pty Ltd

8 Lakeview Drive,
Scoresby 3179, Victoria
Australia
Ph: 1300 556 816

Glen Dimplex New Zealand Ltd

38 Harris Road, East Tamaki,
Auckland 2013
New Zealand
Ph: 0800 666 2824



Recycling: Do not dispose of electrical appliances as unsorted municipal waste. Use separate collection facilities. Contact your local government for information regarding the collection systems available. If electrical appliances are disposed of in landfills or dumps, hazardous substances can leak into the ground water, polluting the food chain and damaging health and well-being.



Customer Care: 1300 556 816
customer.care@glendimplex.com.au
www.dimplex.com.au

Supplied by Glen Dimplex Australia
8 Lakeview Drive, Scoresby, Victoria, 3179

© Glen Dimplex Australia. All rights reserved. Material contained in this publication may not be reproduced in whole or in part, without prior permission in writing of Glen Dimplex Australia.

DF2608-LED v5