



# INSTRUCTION MANUAL



## **Reverse Cycle Wi-Fi Split System**

Model: DCES09WIFI

---

For domestic household use only.













# CONTENTS





---

SAFETY PRECAUTIONS .....	1
NAMES OF PARTS .....	4
INDOOR UNIT DISPLAY .....	5
EMERGENCY FUNCTION & AUTO-RESTART FUNCTION .....	6
REMOTE CONTROLLER .....	7
OPERATING INSTRUCTIONS .....	10
PROTECTION .....	16
INSTALLATION MANUAL.....	17
MAINTENANCE .....	26
TROUBLESHOOTING .....	27

In line with the company's policy of continual product improvement, the aesthetic and dimensional characteristics, technical data and accessories of this appliance may be changed without notice.

# SAFETY RULES AND RECOMMENDATIONS FOR THE INSTALLER

-  Read this guide before installing and using the appliance.
-  During the installation of the indoor and outdoor units the access to the working area should be forbidden to children. Unforeseeable accidents could happen.
-  Make sure that the base of the outdoor unit is firmly fixed.
-  Check that air cannot enter the refrigerant system and check for refrigerant leaks when moving the air conditioner.
-  Carry out a test cycle after installing the air conditioner and record the operating data.
-  The ratings of the fuse installed in the built-in control unit are T 5A / 250V .
-  The user must protect the indoor unit with a fuse of suitable capacity for the maximum input current or with another overload protection device.
-  Check that the socket is suitable for the plug, otherwise have the socket changed.
-  The appliance must be fitted with means for disconnection from the supply mains having a contact separation in all poles that provide full disconnection under overvoltage category III conditions, and these means must be incorporated in the fixed wiring in accordance with the wiring rules.
-  The air conditioner must be installed by professional or qualified persons.

-  Do not install the appliance at a distance of less than 50 cm from inflammable substances (alcohol, etc.) Or from pressurised containers (e.g. spray cans).
  -  If the appliance is used in areas without the possibility of ventilation, precautions must be taken to prevent any leaks of refrigerant gas from remaining in the environment and creating a danger of fire
  -  This appliance is not intended for use by persons (including children) with reduced physical, sensory or mental capabilities, or lack of experience and knowledge, unless they have been given supervision or instruction concerning use of the appliance by a person responsible for their safety.
- Children should be supervised to ensure that they do not play with the appliance.
-  The appliance must be installed in accordance with national wiring regulations.



## SAFETY RULES AND RECOMMENDATIONS FOR THE USER

- ⚠ Do not try to install the conditioner alone; always contact specialized technical personnel.
- ⚠ Cleaning and maintenance must be carried out by specialised technical personnel. In any case disconnect the appliance from the mains electricity supply before carrying out any cleaning or maintenance.
- ⚠ Ensure that the mains voltage corresponds to that stamped on the rating plate. Keep the switch or power plug clean. Insert the power plug correctly and firmly into the socket, thereby avoiding the risk of electric shock or fire due to insufficient contact.
- ⚠ Do not pull out the plug to switch off the appliance when it is in operation, since this could create a spark and cause a fire, etc.
- ⚠ This appliance has been made for air conditioning domestic environments and must not be used for any other purpose, such as for drying clothes, cooling food, etc.
- ⚠ The packaging materials are recyclable and should be disposed of in the separate waste bins. Take the air conditioner at the end of its useful life to a special waste collection centre for disposal.
- ⚠ Always use the appliance with the air filter mounted. The use of the conditioner without air filter could cause an excessive accumulation of dust or waste on the inner parts of the device with possible subsequent failures.
- ⚠ The user is responsible for having the appliance installed by a qualified technician, who must check that it is earthed in accordance with current legislation and insert a thermomagnetic circuit breaker.
- ⚠ The batteries in remote controller must be recycled or disposed of properly.  
Disposal of Scrap Batteries --- Please discard the batteries as sorted municipal waste at the accessible collection point.
- ⚠ Never remain directly exposed to the flow of cold air for a long time. The direct and prolonged exposition to cold air could be dangerous for your health. Particular care should be taken in the rooms where there are children, old or sick people.
- ⚠ If the appliance gives off smoke or there is a smell of burning, immediately cut off the power supply and contact the Service Centre.
- ⚠ The prolonged use of the device in such conditions could cause fire or electrocution.
- ⚠ Have repairs carried out only by an authorised Service Centre of the manufacturer. Incorrect repair could expose the user to the risk of electric shock, etc.
- ⚠ Unhook the automatic switch if you foresee not to use the device for a long time. The airflow direction must be properly adjusted.
- ⚠ The flaps must be directed downwards in the heating mode and upwards in the cooling mode.
- ⚠ Only use the air conditioner as instructed in this booklet. These instructions are not intended to cover every possible condition and situation. As with any electrical household appliance, common sense and caution are therefore always recommended for installation, operation and maintenance.
- ⚠ Ensure that the appliance is disconnected from the power supply when it will remain inoperative for a long period or before carrying out any cleaning or maintenance.
- ⚠ Selecting the most suitable temperature can prevent damage to the appliance.

## SAFETY RULES AND PROHIBITIONS

- ⊖ Do not bend , tug or compress the power cord since this could damage it. Electrical shocks or fire are probably due to a damaged power cord. Specialised technical personnel only must replace a damaged power cord.
- ⊖ Do not use extensions or power board.
- ⊖ Do not touch the appliance when barefoot or parts of the body are wet or damp.
- ⊖ Do not obstruct the air inlet or outlet of the indoor or the outdoor unit.  
The obstruction of these openings causes a reduction in the operative efficiency of the conditioner with possible consequent failures or damages.
- ⊖ In no way alter the characteristics of the appliance.
- ⊖ Do not install the appliance in environments where the air could contain gas , oil or sulphur or near sources of heat.
- ⊖ Do not climb onto or place any heavy or hot objects on top of the appliance.
- ⊖ Do not leave windows or doors open for long when the air conditioner is operating.
- ⊖ Do not direct the airflow onto plants or animals.
- ⊖ A long direct exposition to the flow of cold air of the conditioner could have negative effects on plants and animals.
- ⊖ Do not put the conditioner in contact with water.  
The electrical insulation could be damaged and thus causing electrocution.
- ⊖ Do not climb onto or place any objects on the outdoor unit
- ⊖ Never insert a stick or similar object into the appliance. It could cause injury.
- ⊖ Children should be supervised to ensure that they do not play with the appliance. If the supply cord is damaged, it must be replaced by the manufacturer, its service agent or similarly qualified persons in order to avoid a hazard.

# NAMES OF PARTS

## INDOOR UNIT

No.	Description
1	Front panel
2	Air filter
3	Optional filter (if installed)
4	LED Display
5	Signal receiver
6	Terminal block cover
7	Ionizer generator(if installed)
8	Deflectors
9	Emergency button
10	Indoor unit rating label (Stick position optional)
11	Airflow direction louver
12	Remote controller

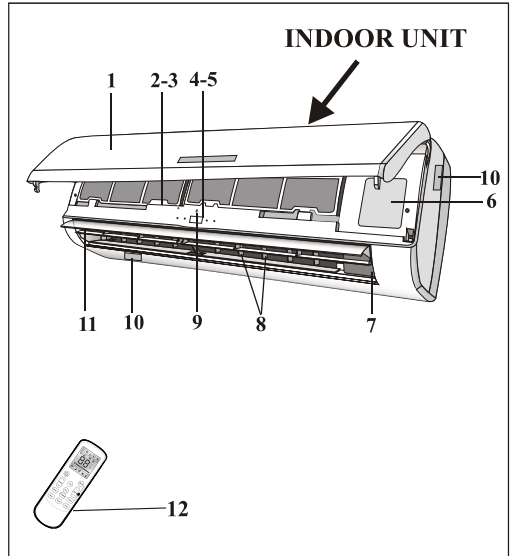

## OUTDOOR UNIT

No.	Description
13	Air outlet grille
14	Outdoor unit rating label
15	Terminal block cover
16	gas valve
17	liquid valve

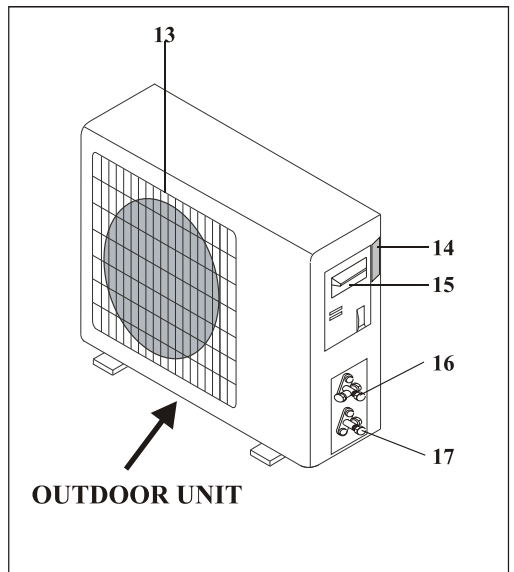

*Note: the above figures are only intended to be a simple diagram of the appliance and may not correspond to the appearance of the units that have been purchased.*

# INDOOR UNIT DISPLAY

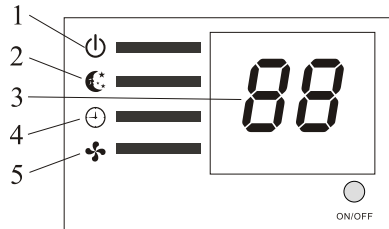
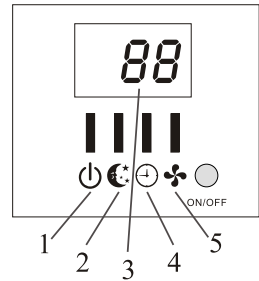
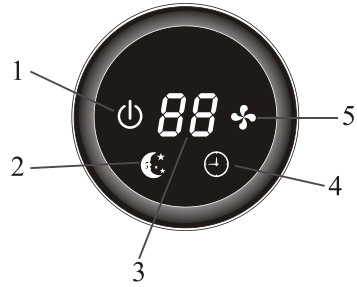
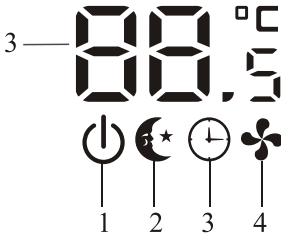
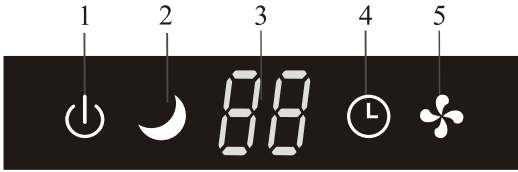
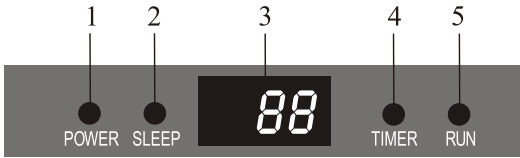

No.	Led		Function
1	POWER		This symbol appears when the unit is power on
2	SLEEP		SLEEP mode
3	Temperature display (if present) /Error code		(1) Lights up during Timer operation when the air conditioner is operational (2) Displays the malfunction code when fault occurs.
4	TIMER		Lights up during Timer operation.
5	RUN		The symbol appears when the unit is turned on, and disappear when the unit is turned off.

The shape and position of switches and indicators may be different according to the model, but their function is the same.

# EMERGENCY FUNCTION & AUTO-RESTART FUNCTION

## AUTO-RESTART FUNCTION

The appliance is preset auto - restart function by manufacturer. In case of a sudden power failure, the module memorizes the setting conditions before the power failure. when the power restores, the unit restarts automatically with all the previous settings preserved by the memory function.

To deactivate the AUTO-RESTART function ,proceed as follows:

1. Switch the air conditioner off and remove the plug.
  2. Press the emergency button meanwhile plug it in.
  3. Keep pressing the emergency button for more than 10 seconds until you hear four short beeps from the unit. The AUTO-RESTART function is deactivate.
- To activate the AUTO - RESTART function , follow the same procedure until you hear three short beeps from the unit.

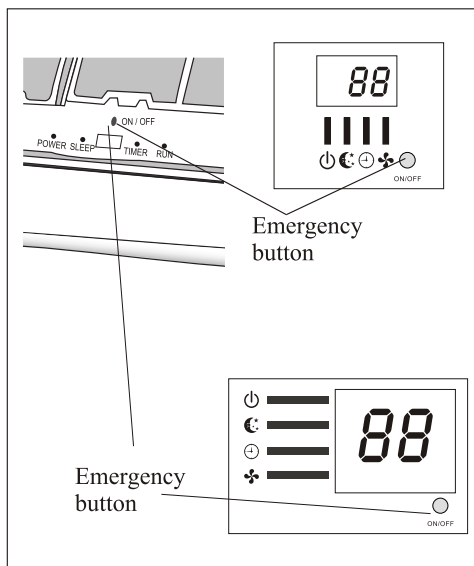

## EMERGENCY FUNCTION

If the remote controller fails to work or maintenance necessary, proceed as follows:

Open and lift the front panel up to an angle to reach the emergency button.

1. One press of the emergency button(one beep) will lead to the forced COOLING operation
2. Two press of the emergency button within 3 sec (two beeps) will lead to the forced HEATING operation.
3. To switch off the unit , you just need to press the button again ( a single long beep) .
4. After 30 minutes in forced operation , the air conditioner will automatically start working in 23°C cooling mode, auto fan speed.

\* The FEEL function is described in page 13.

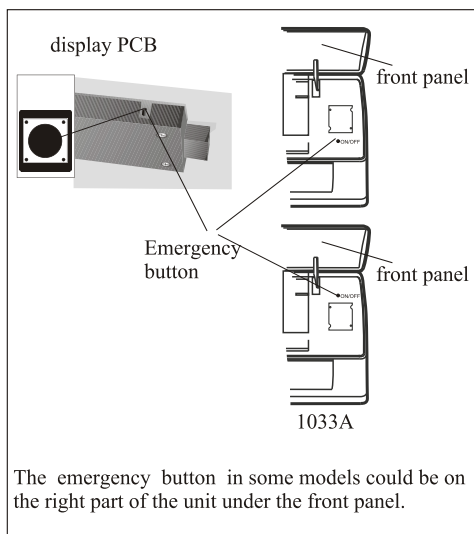

⚠ The shape and position of the emergency button may be different according to the model, but their function is the same.

Remark: the external static pressure of heat pumps is 0 Pa for all models.

⚠ The indoor fan speed during capacity and or efficiency test should be "quick cool" or "quick heat" which can be activated by pressing "TURBO" or "SUPER" button of remote controller; Please contact with the seller in case of failing in activating it.

# REMOTE CONTROLLER

No.	Button	Function
1	▲ (TEMP UP)	Press it to increase temperature / time setting.
2	▼ (TEMP DN)	Press it to decrease temperature / time setting.
3	ON/OFF	Press it to start or stop operation.
4	FAN	To select the fan speed of auto/low/mid/high
5	TIMER	Press it to set auto-off timer.
6	SLEEP	To activate the function "SLEEP"
7	ECO	In cooling mode,press this button ,the temperature will increase 2°C on the base of setting temperature In heating mode, press this button, the temperature will decrease 2°C on the base of setting temperature
8	MODE	To select the mode of operation
9	TURBO	Press this button to activate / deactivate the Super function which enables the unit to reach the preset temperature in the shortest time. In COOL mode, the unit will give the maximum cooling temperature with 16°C,high fan speed. In HEAT mode, the unit will give the maximum heating temperature with 31°C,high fan speed.
10	SWING	To activate or deactivate of the movement of the deflectors.
11	DISPLAY	To switch on/off the LED display
12	MUTE	To activate the function of Mute.
13	I FEEL	To activate the I Feel function.

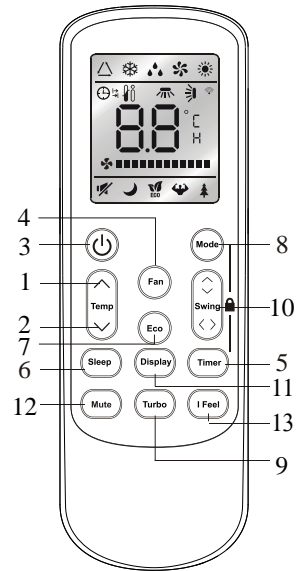

⚠ The outlook and some function of remote control may vary according to the model.





















⚠ The shape and position of buttons and indicators may vary according to the model, but their function is the same.

⚠ The unit confirms the correct reception of each press button with a beep.

# REMOTE CONTROLLER

## Remote controller DISPLAY

### Meaning of symbols on the liquid crystal display

No.	Symbols	Meaning
1		FEEL mode indicator
2		COOLING indicator
3		DEHUMIDIFYING indicator
4		FAN ONLY OPERATION indicator
5		HEATING indicator
6		SIGNAL RECEPTION indicator
7		TIMER OFF indicator
8		TIMER ON indicator
9		AUTO FAN indicator
10		LOW FAN SPEED indicator
11		MIDDLE FAN SPEED indicator
12		HIGH FAN SPEED indicator
13		SLEEP indicator
14		SWING Up-Down indicator
15		SWING Left-Right indicator
16		TUBRO indicator
17		HEALTHY indicator
18		ECO indicator
19		CLOCK indicator
20		I FEEL indicator



# REMOTE CONTROLLER

## Replacement of Batteries

Remove the battery cover plate from the rear of the remote controller, by sliding it in the direction of the arrow.

Install the batteries according the direction (+and -)shown on the Remote Controller.

Reinstall the battery cover by sliding it into place.

⚠ Use 2 LRO 3 AAA (1.5V) batteries . Do not use rechargeable batteries . Replace the old batteries with new ones of the same type when the display is no longer legible.

Do not dispose batteries as unsorted municipal waste. Collection of such waste separately for special treatment is necessary.

⚠ Refer to picture 1:

- i. When you open the battery cover, you can see a DIP switch on the cover back.l

DIP switch on position	Function
°C	The remote controller is adjusted in degree celsius
°F	The remote controller is adjusted in degree fahrenheit.
Cool	The remote controller is adjusted in only cooling mode
Heat	The remote controller is adjusted in cooling and heating mode

- ii. NOTE:After adjusting the function, you need to take out the batteries and repeat the procedure described above.

⚠ Refer to picture 2:

When you insert/change the batteries for the first time in the remote control, you will need to program the remote to cooling or heating function.

When you insert the batteries, the symbols ❄ (COOL ■) and ☀ (HEAT ■) start flashing. If you push whatever button when the symbol ❄( COOL ■) is displayed, the remote controller is adjusted in only cooling mode . If you push whatever button when the symbol ☀:( HEAT ■) is displayed , the remote controller is adjusted in Cooling and heating mode.

⚠ NOTE:if you adjust the remote controller in cooling mode, it will not be possible to activate the heating function in units with heating pump . you need to take out the batteries and repeat the procedure described above.

1. Direct the remote controller toward the Air conditioner.
2. Check that there are no objects between the remote control and the Signal receptor in the indoor unit.
3. Never leave the remote controller exposed to the rays of the sun
4. Keep the remote controller at a distance of at least 1m from the television or other electrical appliances.

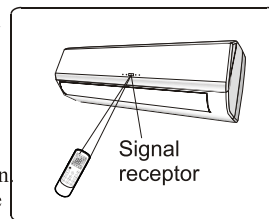
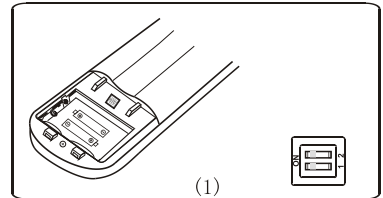
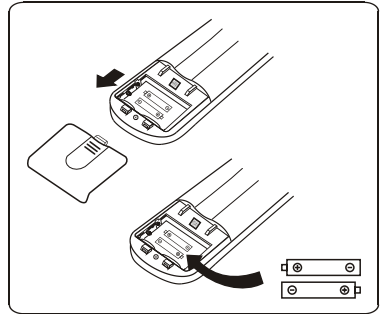

Recommendations for locating and using the remote controller holder (if present)

The remote controller be kept in a wall-mounted holder

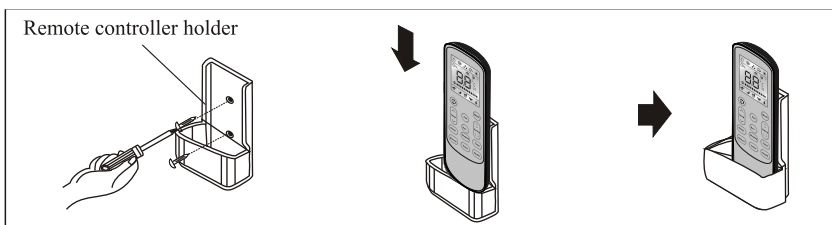



# OPERATING INSTRUCTIONS

The air sucked by the fan enters from the grill and passes through the filter, then it is cooled/dehumidified or heated through the heat exchanger.

The direction of the air outlet is motorized up and down by flaps, and manually moved right and left by the vertical deflectors, for some models, the vertical deflectors could be controlled by motor as well.

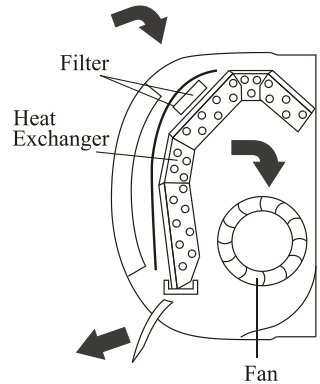

## “SWING” CONTROL OF THE AIR FLOW

### SWING

- The air outlet flow is uniformly distributed in the room.
- It is possible to position the direction of the air in the optimal.

The key **SWING** activates the “FLAP”, the air flow is directed alternatively from up to down. In order to guarantee an even diffusion of the air in the room.

The key **SWING** activates the motorized “deflectors”, the air flow is directed alternatively from left to right. (Optional function, depends on the models)

- In cooling mode, orient the flaps in horizontal direction;
- In heating mode, orient the flaps downward as the warm air tends to rise.

The deflectors are positioned manually and placed under the flaps. They allow to direct the air flow rightward or leftward.

 *This adjustment must be done while the appliance is switched off.*

 Never position “Flaps” manually, the delicate mechanism might be seriously damaged!

 Never poke fingers, sticks or other objects in the air inlet or outlet vents. Such accidental contact with live parts might cause unforeseeable damage or hurt.

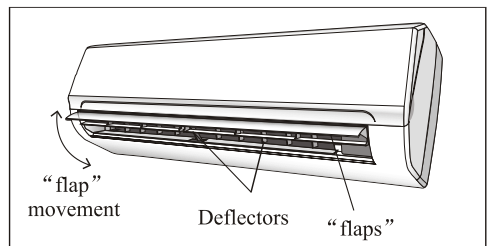
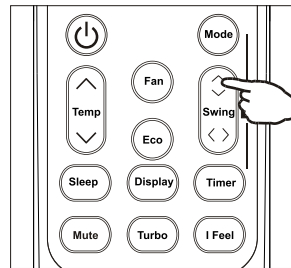
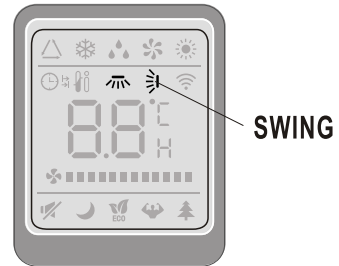

# OPERATING INSTRUCTIONS

## COOLING MODE

### COOL

The cooling function allows the air conditioner to cool the room and at the same time reduces Air humidity.

To activate the cooling function ( COOL ), press the **MODE** button until the symbol ❄️ ( COOL ■ ) appears on the display.

The cooling function is activated by setting the button ▲ or ▼ at a temperature lower than that of the room.

To optimize the function of the Air conditioner, adjust the temperature ( 1 ), the speed ( 2 ) and the direction of the air flow ( 3 ) by pressing the button indicated.

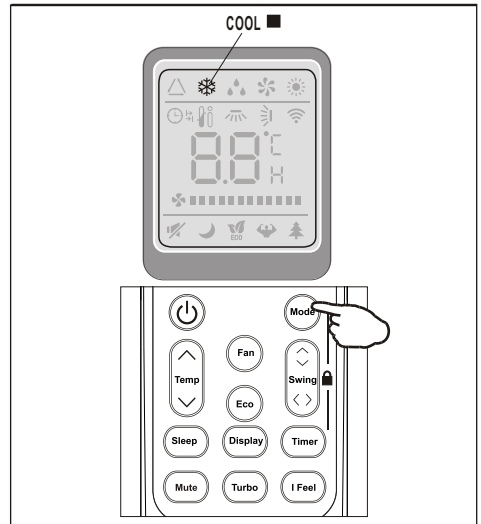

## HEATING MODE

### HEAT

The heating function allows the air conditioner to heat the room.

To activate the heating function ( HEAT ), press the **MODE** button until the symbol ☀️ ( HEAT ■ ) appears on the display.

With the button ▲ or ▼ set a temperature higher than that of the room..

To optimize the function of the Air conditioner adjust the temperature ( 1 ), the speed ( 2 ) and the direction of the air flow ( 3 ) by pressing the button indicated

⚠️ If the appliance is fitted with a electrical heater, which delays appliance to startup in a few seconds to ensure an immediate output of hot air (Optional , depends on the model).

⚠️ In HEATING operation, the appliance can automatically activate a defrost cycle, which is essential to clean the frost on the condenser so as to recover its heat exchange function. This procedure usually lasts for 2-10 minutes during defrosting, indoor unit fan stop operation. After defrosting ,it resumes to HEATING mode automatically.

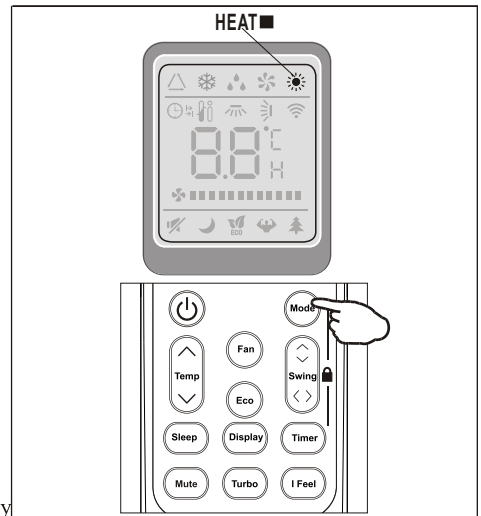

# OPERATING INSTRUCTIONS

## TIMER MODE----TIMER ON

### TIMER

To set the time of the air conditioner

To program the automatical switching-on time, the appliance should be power off.

Press **TIMER** at the first time , set the temperature with pressing the button ▲ or ▼;

Press **TIMER** at the second time , set the rest time with pressing the button ▲ or ▼;

Press **TIMER** at the third time, confirm the setting, then the rest time to next automatical switching-on could be read on the display.

### NOTE !

Before proceeding with the time: program the working mode with the button **MODE** (2) and the fan speed with the button **FAN** (3) . Switch the conditioner off (with the key **ON/OFF** ).

Note:To cancel the set function ,press the **TIMER** button again.

Note:In case of power off,it is necessary to set **TIMER ON** again

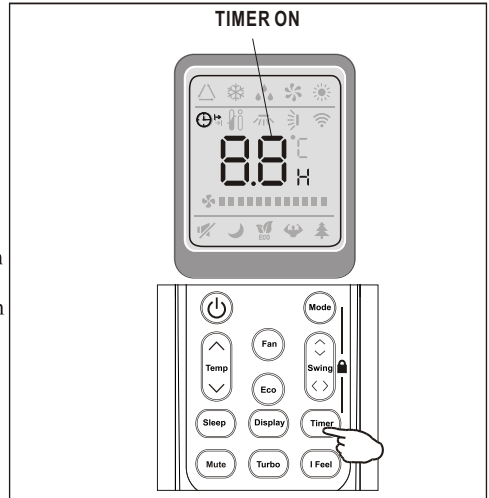

## TIMER MODE----TIMER OFF

### TIMER

To set the automatic switching-off of the air conditioner

The timed stop is programmed by pressing **TIMER** , Set the rest time by pressing the button ▲ or ▼,until the rest time displayed is to your demand then press **TIMER** again.

Note:To cancel the set function, press the **TIMER** button again.

Note:In case of power off,it is necessary to set **TIMER OFF** again

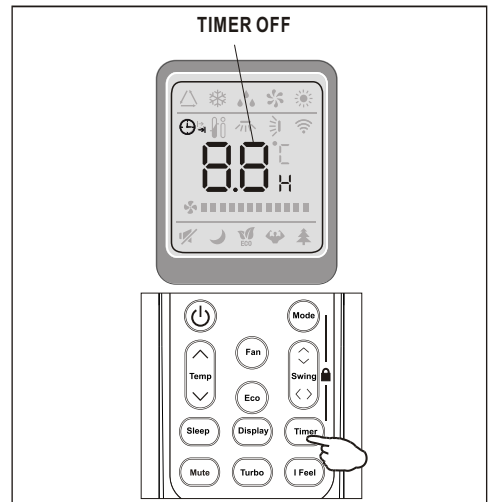

⚠ Note: When the time is set correctly on the remote, the timer function can be used and set in half hour increments.



# OPERATING INSTRUCTIONS

## FAN MODE

**FAN ■**

The conditioner works in only ventilation.

To set the FAN mode, Press **MODE** until ( **FAN ■** ) appears in the display.

While pressing **FAN** button the speed changes in the following sequence: LOW/ MEDIUM/HIGH /AUTO in FAN mode.

The remote control also stores the speed that was set in the previous mode of operation.

In FEEL mode (automatic) the air conditioner automatically chooses the fan speed and the mode of operation (COOLING or HEATING).

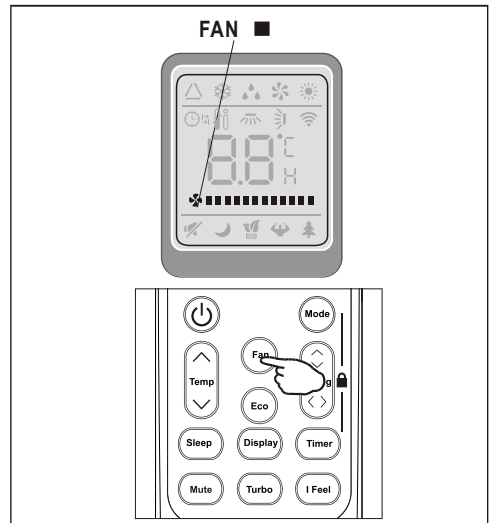

## DRY MODE

**DRY ■**

This function reduces the humidity of the air to make the room more comfortable.

To set the DRY mode, Press **MODE** until ( **DRY ■** ) appears in the display. An automatic function of alternating cooling cycles and air fan is activated.

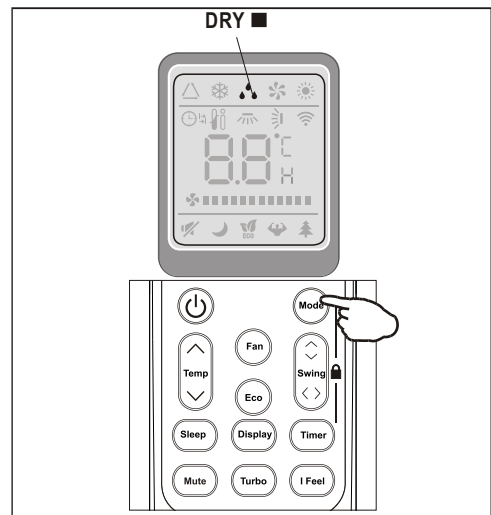

# OPERATING INSTRUCTIONS

## I FEEL MODE

FEEL

Automatic mode.

To activate the I FEEL (automatic) mode of operation, press the **[MODE]** button on the remote controller until the symbol  $\triangle$  (FEEL  $\blacksquare$ ) appears on the display.

In I FEEL mode the fan speed and the temperature are set automatically according to the room temperature (tested by the temperature sensor which is incorporated in the indoor unit).

Ambient temp	Operation mode	Auto temp.
< 20°C	HEATING (FOR HEAT PUMP TYPE) FAN (FOR COOL ONLY TYPE)	23°C
20°C~26°C	DRY	18°C
> 26°C	COOL	23°C

To optimize the function of the air conditioner, adjust the temperature (only  $\pm 2^\circ\text{C}$ ) (1), the speed (2) and the direction of the air flow (3) by pressing the buttons indicated

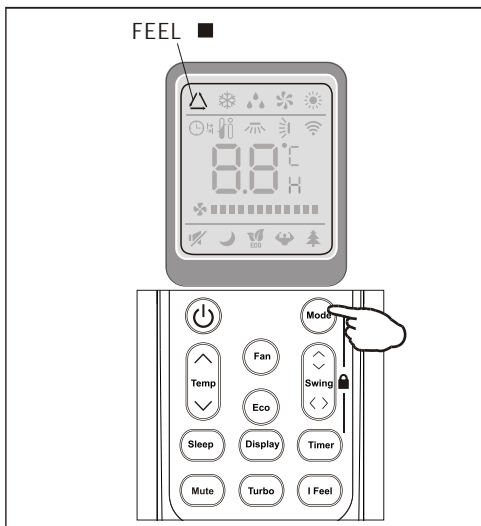

## SLEEP MODE

AUTO QUIET

To activate the SLEEP mode of operation, press the **[SLEEP]** button on the remote controller until the symbol (AUTOQUIET) appears on the display.

The function “SLEEP” automatically adjusts the temperature to make the room more comfortable during the night. In cooling or dry mode, the set temperature will automatically raise by  $1^\circ\text{C}$  every 60 minutes, to achieve a total rise of  $2^\circ\text{C}$  during the first 2 hours of operation.

In heating mode the set temperature is gradually decreased by  $2^\circ\text{C}$  during the first 2 hours of operation.

After 10 hours running in sleep mode the air conditioner is switched off automatically.

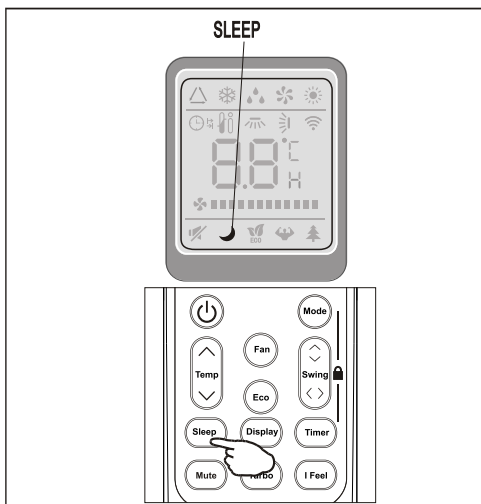

# MODES OF OPERATION

## I FEEL MODE

I Feel

Automatic mode.

To activate I Feel function, press the **I Feel** button on the remote controller. Press again to deactivate this function.

This function enable the remote control measure the temperature at its current location and send this signal 7 times in 2 hours to the air conditioner to enable the air conditioner to optimize the temperature around you and ensure maximum comfort.

It will automatically deactivate 2 hours late after the activation or temperature exceed the range 0~50 °C

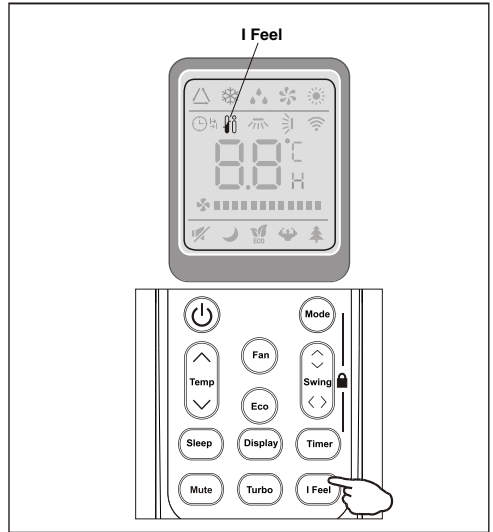

## Child-Lock



Press "Mode" and "Timer" together to active/disactive.

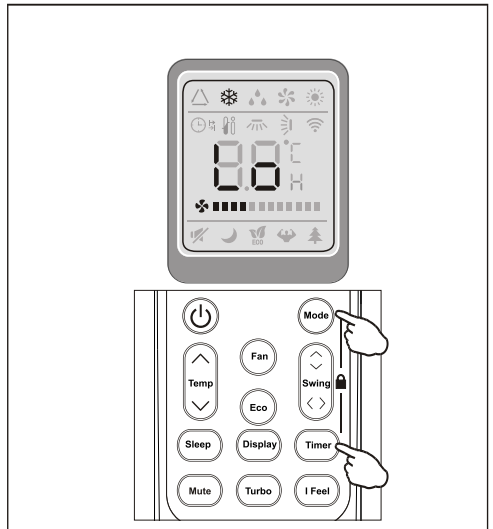

# PROTECTION

The air conditioner is programmed for comfortable and suitable living conditions, if it is used in abnormal conditions as below, certain safety protection features might come into effect.

## For T1 Climate condition models:

No.	MODE	Ambient temperature
1	Heating	Outdoor temperature is $-15^{\circ}\text{C}\sim 28^{\circ}\text{C}$
		Room temperature is $< 30^{\circ}\text{C}$
2	Cooling	Outdoor temperature is $-15^{\circ}\text{C}\sim 52^{\circ}\text{C}$
		Room temperature is $> 17^{\circ}\text{C}$
3	Dry	Outdoor temperature is $-15^{\circ}\text{C}\sim 52^{\circ}\text{C}$
		Room temperature is $> 6^{\circ}\text{C}$

 *The unit does not operate immediately if it is turned on after being turned off or after changing the mode during operation. this is a normal self-protection action, you need wait for about 3 minutes.*

# INSTALLATION MANUAL---Selecting the Installation Place

## INDOOR UNIT

- Install the indoor unit on a strong wall that is not subject to vibrations.
- The inlet and outlet ports should not be obstructed; the air should be able to blow all over the room.
- Do not install the unit near a source of heat, steam, or flammable gas.
- Install the unit near an electric socket or private circuit.
- Do not install the unit where it will be exposed to direct sunlight.
- Select a site where the condensed water can be easily drained out, and where it is easily connected to outdoor unit.
- Check the machine operation regularly and reserve the necessary spaces as shown in the picture.
- Select a place where the filter can be easily taken out.

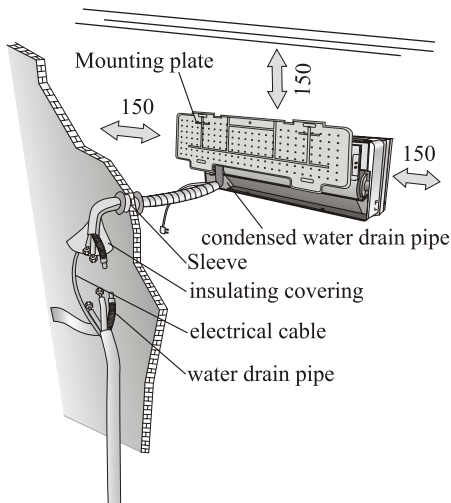

## OUTDOOR UNIT

- Do not install the outdoor unit near sources of heat, steam or flammable gas.
- Do not install the unit in too windy or dusty places.
- Do not install the unit where people often pass. Select a place where the air discharge and operating sound will not disturb the neighbours.
- Avoid installing the unit where it will be exposed to direct sunlight (other wise use a protection, if necessary, that should not interfere with the air flow).
- Reserve the spaces as shown in the picture for the air to circulate freely.
- Install the outdoor unit in a safe and solid place.
- If the outdoor unit is subject to vibration, place rubber gaskets onto the feet of the unit..

minimum space to be reserved (mm) showing in the picture

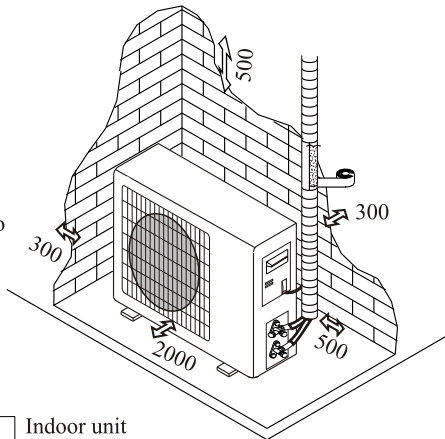

### Installation Diagram

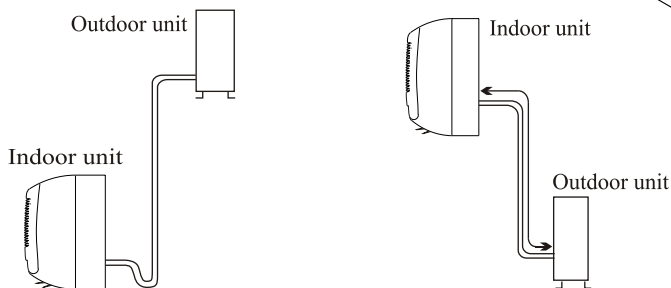

The purchaser must ensure that the person and/or company who is to install, maintain or repair this air conditioner has qualifications and experience in refrigerant products.



# INSTALLATION MANUAL---Installation of the Indoor unit

Before starting installation, decide on the position of the indoor and outdoor units, taking into account the minimum space reserved around the units

- ⚠ Do not install your air conditioner in a wet room such as a bathroom or laundry etc
- ⚠ The installation site should be 250cm or more above the floor.

**To install, proceed as follows:**

## Installation of the mounting plate

- 1 Always mount the rear panel horizontally and vertically
2. Drill 32 mm deep holes in the wall to fix the plate;
3. Insert the plastic anchors into the hole;
4. Fix the rear panel on the wall with provided tapping screws
5. Be sure that the rear panel has been fixed firmly enough to withstand the weight

*Note : The shape of the mounting plate may be different from the one above, but installation method is similar .*

## Drilling a hole in the wall for the piping

1. Make the piping hole ( $\Phi 55$ ) in the wall at a slight downward slant to the outdoor side.
2. Insert the piping-hole sleeve into the hole to prevent the connection piping and wiring from being damaged when passing through the hole.

- ⚠ The hole must slope downwards towards the exterior

*Note : Keep the drain pipe down towards the direction of the wall hole, otherwise leakage may occur.*

## Electrical connections---Indoor unit

1. Open the front panel.
2. Take off the cover as indicated in the picture ( by removing a screw or breaking the hooks).
3. For the electrical connections, see the circuit diagram on the right part of the unit under the front panel.
4. Connect the cable wires to the screw terminals by following the numbering ,Use wire size suitable to the electric power input (see name plate on the unit) and according to all current national safety code requirements.

- ⚠ The cable connecting the outdoor and indoor units must be suitable for outdoor use.

- ⚠ The plug must be accessible also after the appliance has been installed so that it can be pulled out if necessary.

- ⚠ An efficient earth connection must be ensured.
- ⚠ If the power cable is damaged, it must be replaced by an authorised Service Centre.

*Note: Optional the wires can be connected to the main PCB of indoor unit by manufacturer according to the model without terminal block.*

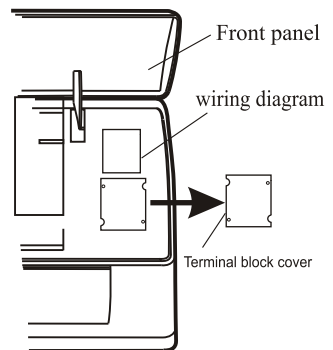
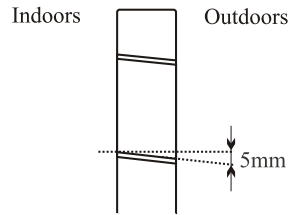
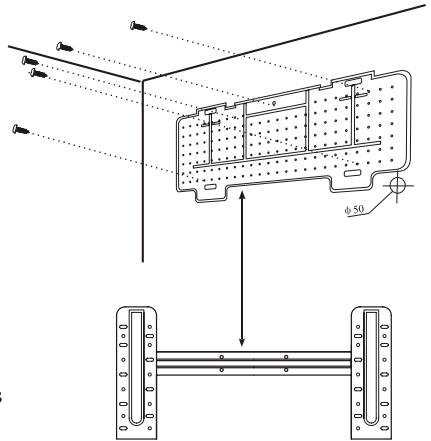

# INSTALLATION MANUAL---Installation of the Indoor unit

## Refrigerant piping connection

The piping can be run in the 3 directions indicated by numbers in the picture . When the piping is run in direction 1 or 3, cut a notch along the groove on the side of the indoor unit with a cutter.

Run the piping in the direction of the wall hole and bind the copper pipes , the drain pipe and the power cables together with the tape with the drain pipe at the bottom, so that water can flow freely.

- Do not remove the cap from the pipe until connecting it, to avoid dampness or dirt from entering.
- If the pipe is bent or pulled too often , it will become stiff . Do not bend the pipe more than three times at one point.
- When extending the rolled pipe, straighten the pipe by unwinding the rolled pipe, as shown in the picture.

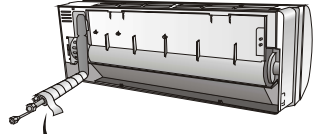
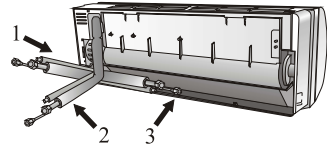

Shape the connection pipe

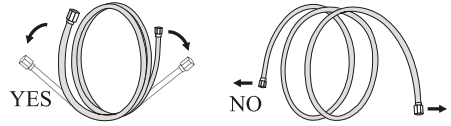

Extending the rolled pipe

## Connections to the indoor unit

1. Remove the indoor unit pipe cap (check that there is no debris inside).
2. Insert the flare nut and create a flange at the extreme end of the connection pipe.
3. Tighten the connections by using two wrenches working in opposite directions

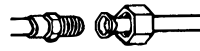

torque wrench

## Indoor unit condensed water drainage

The indoor unit condensed water drainage is fundamental for the success of the installation.

1. Place the drain hose below the piping, taking care not to create siphons.
2. The drain hose must slant downwards to aid drainage.
3. Do not bend the drain hose or leave it protruding or twisted and do not put the end of it in water . If an extension is connected to the drain hose , ensure that it is lagged when it passes into the indoor unit.
4. If the piping is installed to the right, the pipes, power cable and drain hose must be lagged and secured onto the rear of the unit with a pipe connection.
  - 1) Insert the pipe connection into the relative slot.
  - 2) Press to join the pipe connection to the base.

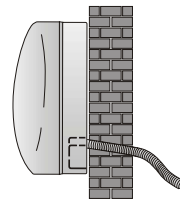

YES

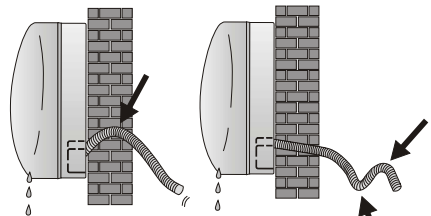

NO

NO

# INSTALLATION MANUAL---Installation of the Indoor unit

## INSTALLATION OF THE INDOOR UNIT

After having connected the pipe according to the instructions, install the connection cables. Now install the drain pipe. After connection, lag the pipe, cables and drain pipe with the insulating material.

1. Arrange the pipes ,cables and drain hose well.
2. Lag the pipe joints with insulating material , securing it with vinyl tape.
3. Run the bound pipe , Cables and drain pipe through the wall hole and mount the indoor unit onto the upper part of the mounting plate securely.
4. Press and push the lower part of the indoor unit tightly against the mounting plate

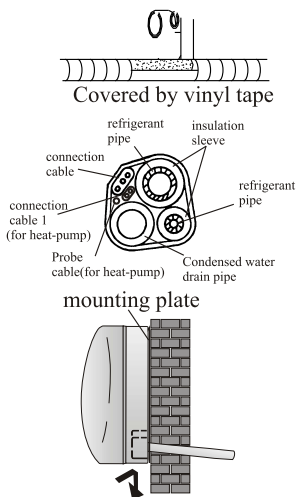

# INSTALLATION MANUAL---Installation of the indoor unit

- The indoor unit should be installed on a solid wall and fastened securely.
- The following procedure must be observed before connecting the pipes and connecting cables : decide which is the best position on the wall and leave enough space to be able to carry out maintenance easily.
- Fasten the support to the wall using screw anchors which are particularly suited to the type of wall;
- Use a larger quantity of screw anchors than normally required for the weight they have to bear to avoid vibration during operation and remain fastened in the same position for years without the screws becoming loose.
- The unit must be installed following the national regulations.

## Outdoor unit condensed water drainage (only for heat pump models)

The condensed water and the ice formed in the outdoor unit during heating operation can be drained away through the drain pipe

1. Fasten the drain port in the 25mm hole placed in the part of the unit as shown in the picture.
2. Connect the drain port and the drain pipe. Pay attention that water is drained in a suitable place.

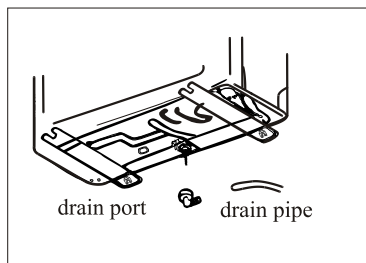

# INSTALLATION MANUAL---Installation of the outdoor unit

## ELECTRICAL CONNECTIONS

1. Remove the handle on the right side plate of outdoor unit.
2. Connect the power connection cord to the terminal board.  
Wiring should fit that of indoor unit.
3. Fix the power connection cord with wire clamp.
4. Confirm if the wire has been fixed properly.
5. An efficient earth connection must be ensured.
6. Recover the handle.

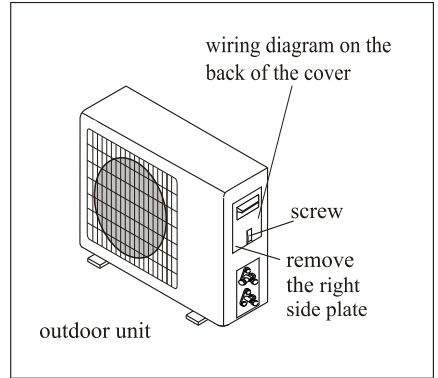

## CONNECTING THE PIPES

Screw the flare nuts to the outdoor unit coupling with the same tightening procedures described for the indoor unit.

To avoid leakage, pay attention to the following points:

1. Tighten the flare nuts using two wrenches. Pay attention not to damage the pipes.
2. If the tightening torque is not sufficient, there will probably be some leakage. With excessive tightening torque there will also be some leakage, as the flange could be damaged.
3. The surest system consists in tightening the connection by using a fix wrench and a torque wrench: in this case use the table on page 22.

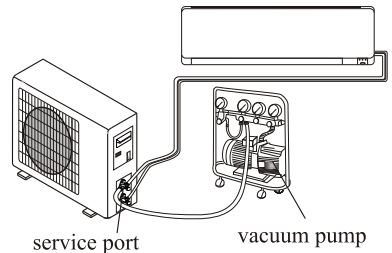
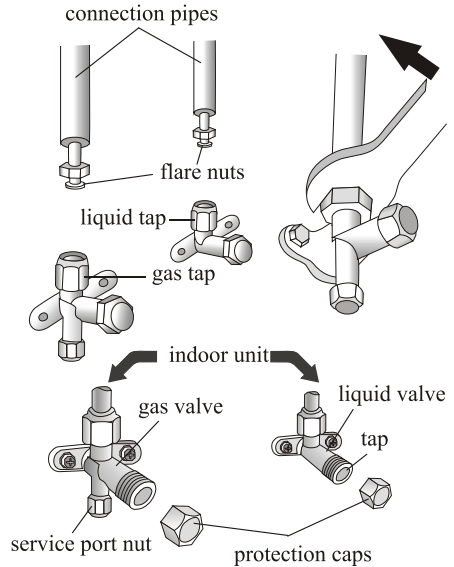

# INSTALLATION MANUAL---Installation of the outdoor unit

## BLEEDING

The air and humidity left inside the refrigerant circulation can cause compressor malfunction. After having connected the indoor and outdoor units, bleed the air and humidity from the refrigerant circulation using a vacuum pump.

- (1) Unscrew and remove the caps from the 2 - way and 3-way valves.
- (2) Unscrew and remove the cap from the service port.
- (3) Connect the vacuum pump hose to the service port.
- (4) Operate the vacuum pump for 10 - 15 minutes until an absolute vacuum of 10 mm Hg has been reached.
- (5) With the vacuum pump still in operation, close the low - pressure knob on the vacuum pump coupling. Stop the vacuum pump.
- (6) Open the 2 - way valve by 1/4 turn and then close it after 10 seconds. Check all the joints for leaks using liquid soap or an electronic leak device.
- (7) Turn the body of the 2-way and 3-way valves. Disconnect the vacuum pump hose.
- (8) Replace and tighten all the caps on the valves.

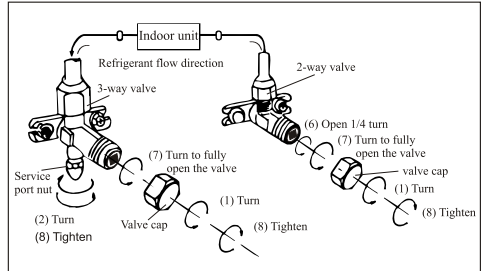
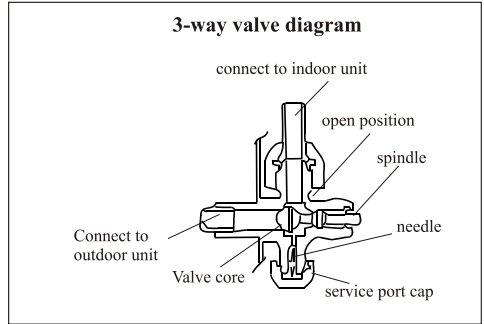

## INSTALLATION MANUAL--- operation test

1. Wind insulating covering around the joints of the indoor unit and fix it with insulating tape.
2. Fix the exceeding part of the signal cable to the piping or to the outdoor unit.
3. Fix the piping to the wall ( after having coated it with insulating tape) using clamps or insert them into plastic slots.
4. Seal the hole in the wall through which the piping is passed so that no air or water can enter.

### Indoor unit test

- Do the ON/OFF and FAN operate normally?
- Does the MODE operate normally?
- Do the set point and TIMER function properly?
- Does each lamp light normally?
- Do the flap for air flow direction operate normally?
- Is the condensed water drained regularly?

### Outdoor unit test

- Is there any abnormal noise or vibration during operation?
- Could the noise, the air flow or the condensed water drainage disturb the neighbours?
- Is there any coolant leakage?

*Note: the electronic controller allows the compressor to start only three minutes after voltage has reached the system.*

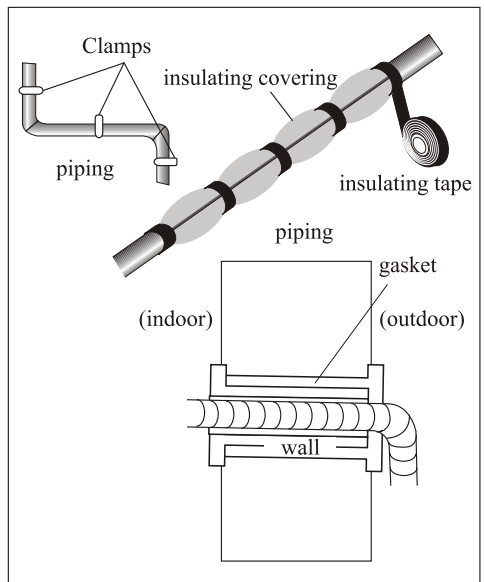

# INSTALLATION MANUAL---Information for the installer

<b>FIXED-SPEED TYPE MODEL capacity (Btu/h)</b>	<b>9k</b>	<b>12k</b>	<b>18k</b>	<b>24k</b>
<b>Liquid pipe diameter</b>	1/4 " (φ6)	1/4 " (φ6)	1/4 " (φ6)	3/8 " (φ9.52)
<b>Gas pipe diameter</b>	3/8 " (φ9.52)	1/2 " (φ12)	1/2 " (φ12)	5/8 " (φ15.88)
<b>Length of pipe with standard charge</b>	5m	5m	5m	5m
<b>Type of refrigerant(1)</b>	R410A	R410A	R410A	R410A

<b>INVERTER TYPE MODEL capacity (Btu/h)</b>	<b>9k</b>	<b>12k</b>	<b>18k</b>	<b>24k</b>	<b>28k</b>
<b>Liquid pipe diameter</b>	1/4 " (φ6)	1/4 " (φ6)	1/4 " (φ6)	3/8 " (φ9.52)	3/8 " (φ9.52)
<b>Gas pipe diameter</b>	3/8 " (φ9.52)	3/8 " (φ9.52)	1/2 " (φ12)	5/8 " (φ15.88)	5/8 " (φ15.88)
<b>Length of pipe with standard charge</b>	5m	5m	5m	5m	5m
<b>Type of refrigerant(1)</b>	R410A	R410A	R410A	R410A	R410A

(1) Refer to the data rating label stuck on the outdoor unit.

## TIGHTENING TORQUE FOR PROTECTION CAPS AND FLANGE CONNECTION

<b>PIPE</b>	<b>TIGHTENING TORQUE [N x m]</b>	<b>CORRESPONDING STRESS (using a 20 cm wrench)</b>		<b>TIGHTENING TORQUE [N x m]</b>
1/4 " (φ6)	15 - 20	wrist strength	Service port nut	7 - 9
3/8 " (φ9.52)	31 - 35	arm strength	Protection caps	25 - 30
1/2 " (φ12)	35 - 45	arm strength		
5/8 " (φ15.88)	75 - 80	arm strength		

# INSTALLATION MANUAL---Information for the installer

## WIRING DIAGRAM

For different models, the wiring diagram may be different. Please refer to the wiring diagrams pasted on the indoor unit and outdoor unit respectively.

On indoor unit, the wiring diagram is pasted under the front panel;  
On outdoor unit, the wiring diagram is pasted on the backside of the outdoor handle cover.

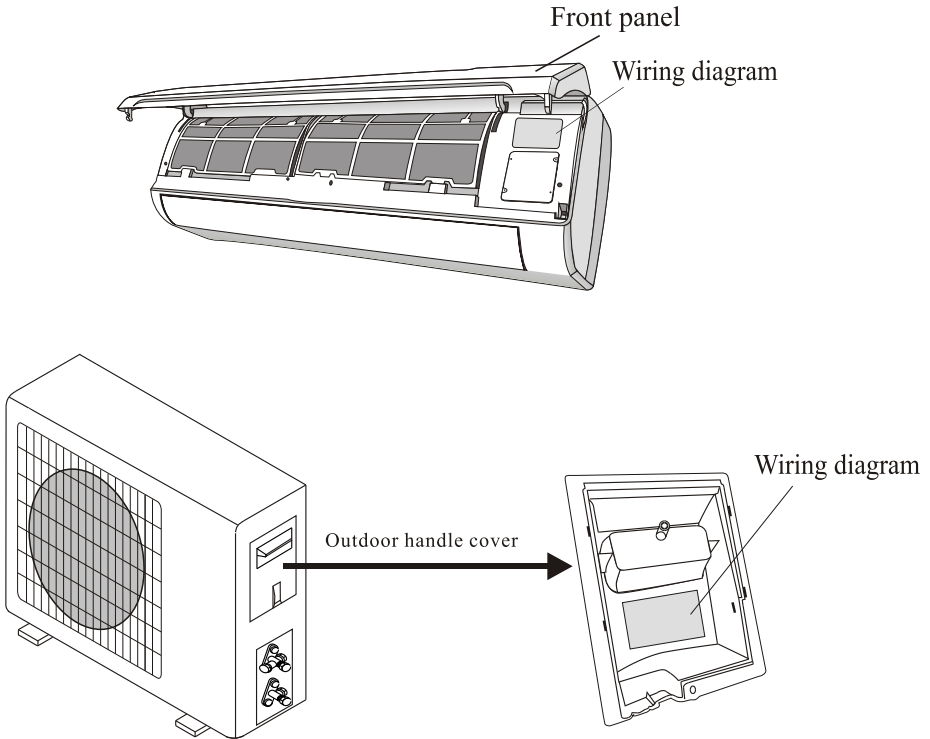

*Note: For some models the wires has been connected to the main PCB of indoor unit by manufacturer without terminal block.*

# INSTALLATION MANUAL---Information for the installer

## CABLE WIRES SPECIFICATION

FIXED-SPEED TYPE MODEL capacity (Btu/h)		9k	12k	18k	24k
		sectional area			
Power supply cable	N	1.5mm <sup>2</sup> AWG16	1.5mm <sup>2</sup> AWG16	1.5mm <sup>2</sup> AWG16	2.5mm <sup>2</sup> AWG14 H05RN-F
	L	1.5mm <sup>2</sup> AWG16	1.5mm <sup>2</sup> AWG16	1.5mm <sup>2</sup> AWG16	2.5mm <sup>2</sup> AWG14 H05RN-F
	E	1.5mm <sup>2</sup> AWG16	1.5mm <sup>2</sup> AWG16	1.5mm <sup>2</sup> AWG16	2.5mm <sup>2</sup> AWG14 H05RN-F
Connection supply cable	N	1.5mm <sup>2</sup>	1.5mm <sup>2</sup>	1.5mm <sup>2</sup>	0.75mm <sup>2</sup>
	L	/	/	/	0.75mm <sup>2</sup>
	1	1.5mm <sup>2</sup>	1.5mm <sup>2</sup>	1.5mm <sup>2</sup>	0.75mm <sup>2</sup>
	2	0.75mm <sup>2</sup>	0.75mm <sup>2</sup>	0.75mm <sup>2</sup>	0.75mm <sup>2</sup>
	3	0.75mm <sup>2</sup>	0.75mm <sup>2</sup>	0.75mm <sup>2</sup>	0.75mm <sup>2</sup>
	⊕	1.5mm <sup>2</sup>	1.5mm <sup>2</sup>	1.5mm <sup>2</sup>	0.75mm <sup>2</sup>

INVERTER TYPE MODEL capacity (Btu/h)		9k	12k	18k	24k	28k
		sectional area				
Power supply cable	N	1.5mm <sup>2</sup> AWG16	1.5mm <sup>2</sup> AWG16	1.5mm <sup>2</sup> AWG16	2.5mm <sup>2</sup> AWG14	2.5mm <sup>2</sup> AWG14
	L	1.5mm <sup>2</sup> AWG16	1.5mm <sup>2</sup> AWG16	1.5mm <sup>2</sup> AWG16	2.5mm <sup>2</sup> AWG14	2.5mm <sup>2</sup> AWG14
	E	1.5mm <sup>2</sup> AWG16	1.5mm <sup>2</sup> AWG16	1.5mm <sup>2</sup> AWG16	2.5mm <sup>2</sup> AWG14	2.5mm <sup>2</sup> AWG14
Connection supply cable	N	1.5mm <sup>2</sup>	1.5mm <sup>2</sup>	1.5mm <sup>2</sup>	0.75mm <sup>2</sup>	0.75mm <sup>2</sup>
	L	1.5mm <sup>2</sup>	1.5mm <sup>2</sup>	1.5mm <sup>2</sup>	0.75mm <sup>2</sup>	0.75mm <sup>2</sup>
	1	1.5mm <sup>2</sup>	1.5mm <sup>2</sup>	1.5mm <sup>2</sup>	0.75mm <sup>2</sup>	0.75mm <sup>2</sup>
	⊕	1.5mm <sup>2</sup>	1.5mm <sup>2</sup>	1.5mm <sup>2</sup>	0.75mm <sup>2</sup>	0.75mm <sup>2</sup>

220V 9K , 12K, 18K, 24K, air conditioner indoor unit fuse parameter is 50T, 3.15A



# MAINTENANCE

Periodic maintenance is essential for keeping your air conditioner efficient.

Before carrying out any maintenance, disconnect the power supply by taking the plug out from the socket.

## INDOOR UNIT

### ANTIDUST FILTERS

1. Open the front panel following the direction of the arrow
2. Keeping the front panel raised with one hand, take out the air filter with the other hand
3. Clean the filter with water; if the filter is soiled with oil, it can be washed with warm water (not exceeding 45°C).  
Leave to dry in a cool and dry place.
4. Keeping the front panel raised with one hand, insert the air filter with the other hand
5. Close

The electrostatic and the deodorant filter (if installed) cannot be washed or regenerated and must be replaced with new filters after every 6 months.

### CLEANING THE HEAT EXCHANGER

1. Open the front panel of the unit and lift it till its greatest stroke and then unhooking it from the hinges to make the cleaning easier.
2. Clean the indoor unit using a cloth with the water (not higher than 40°C) and neutral soap. Never use aggressive solvents or detergents.
3. If the outdoor unit is clogged, remove the leaves and the waste and remove the dust with air jet or a bit of water.

### END OF SEASON MAINTENANCE

1. Disconnect the automatic switch or the plug.
2. Clean and replace the filters
3. On a sunny day let the conditioner work in ventilation for some hours, so that the inside of the unit can dry completely..

### REPLACING THE BATTERIES

When:

- There is no confirmation beep heard from the indoor unit.
- The LCD doesn't act.

How:

- Take off the cover at back.
- Place the new batteries respecting the symbols + and -.

N.B: Use only new batteries. Remove the batteries from the remote controller when the conditioner is not in operation

**WARNING!** Do not throw batteries into common rubbish, they should be disposed of in the special containers situated in the collection points.

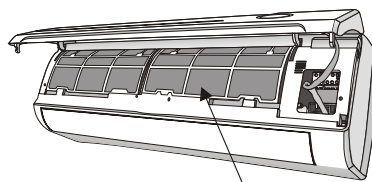
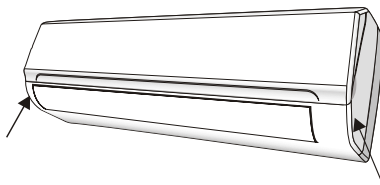

antidust filter

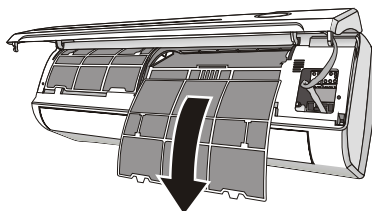

# TROUBLESHOOTING

MALFUNCTION	POSSIBLE CAUSES	
The appliance does not operate	Power failure/plug pulled out	
	Damaged indoor/outdoor unit fan motor	
	Faulty compressor thermomagnetic circuit breaker	
	Faulty protective device or fuses.	
	Loose connections or plug pulled out	
	It sometimes stops operating to protect the appliance.	
	Voltage higher or lower than the voltage range	
	Active TIMER-ON function	
Strange odour	Damaged electronic control board	
Strange odour	Air filter dirty	
Noise of running water	Back flow of liquid in the refrigerant circulation	
A fine mist comes from the air outlet	This occurs when the air in the room becomes very cold, for example in the “COOLING” or “DEHUMIDIFYING/DRY” modes.	
A strange noise can be heard	This noise is made by the expansion or contraction of the front panel due to variations in temperature and does not indicate a problem.	
Insufficient airflow, either hot or cold	Inappropriate temperature setting..	
	Air inlet or outlet of indoor or outdoor unit has been blocked.	
	Air filter is blocked.	
	Fan speed set at minimum.	
	Other sources of heat in the room.	
The appliance does not respond to commands	No refrigerant.	
	Remote control is not near enough to indoor unit.	
	Battery in Remote controller may have been exhausted..	
The display is off	Obstacles between remote control and signal receiver in indoor unit.	
	Active LED function	
	Power failure	
<b>Switch off the air conditioner immediately and cut off the power supply in the event of:</b>		
Strange noises during operation.		
Faulty electronic control board		
Faulty fuses or switches.		
Spraying water or objects inside the appliance.		
Overheated cables or plugs.		
Very strong smells coming from the appliance.		
<b>ERROR SIGNALS ON THE DISPLAY</b>		
In case of error, the display on the indoor unit shown the following error codes:		
	RUN lamp	Description of the trouble
<i>E1</i>	flashes once	The fault of indoor temperature sensor
<i>E2</i>	flashes twice	The fault of indoor pipe temperature sensor
<i>E6</i>	flashes 6 times	Malfunction of indoor fan motor.





**Customer Care:** 1300 556 816  
customer.care@glendimplex.com.au  
www.dimplex.com.au

Supplied by Glen Dimplex Australia  
1340 Ferntree Gully Road, Scoresby, Victoria, 3179

---

© Glen Dimplex Australia. All rights reserved. Material contained in this publication may not be reproduced in whole or in part, without prior permission in writing of Glen Dimplex Australia.



# Wi-Fi Function User Manual



This description is applied to Air Conditioners with Wi-Fi function. Please read the manual carefully before using the product and keep it for future reference.

# CONTENTS

---

Smart phone Environment and Wi-Fi Module .....	1
Downloading and Installing the App .....	2
Activate APP .....	4
Login-Registration for new user .....	6
Login-Forget the Password .....	7
Login .....	7
Add device .....	8
Air conditioner control .....	9
Tips of the device .....	21
News .....	21
Share the device .....	22
Account and Help .....	23
Notice.....	24
Trouble Shooting .....	24

# Smart phone Environment and Wi-Fi Module

## 1. Minimum specifications on a Smart phone:

Android 5.0 version or higher

IOS 9.0 version or higher

## 2. Wireless Network Requirements of Wi-Fi module

Features \ Standard	IEEE 802.11 b	IEEE 802.11 g	IEEE 802.11 n
Operating frequency	2400 - 2483.5MHz ISM band	2400 -2483.5MHz ISM band	2400 -2483.5MHz ISM band
Modulation	DQPSK,DBPSK CCK,DSSS	QPSK,BPSK,16QAM 64QAM with OFDM	BPSK,QPSK,16QAM 64QAM with OFDM
Channel numbers	13 channels for worldwide	13 channels for worldwide	
Data rate	At most 11Mbps	At most 54Mbps	At most 150Mbps
Sensitivity	-76dBm for 11Mbps	-65dBm for 54Mbps	-64dBm at MCS7 (2.4GHz band/HT20) -61dBm at MCS7 (2.4GHz band/HT40)
Output Power	16±2dBm for 11Mbps	14±2dBm for 54Mbps	12±2dBm at MCS7 (2.4GHz band/HT20) 12±2dBm at MCS7 (2.4GHz band/HT40)
security	Standard: WEP/WEPa/WPA2 encryption algorithm: WEP64/WEP128/TKIP/AES		

## 3. Where is the Wi-Fi module and The MAC address

Open the front panel, the Wi-Fi module is nearby the electric box cover or on the panel.

The MAC address is the ID of a Wi-Fi module, it's very important for after service, please don't remove or destroy the MAC address label.

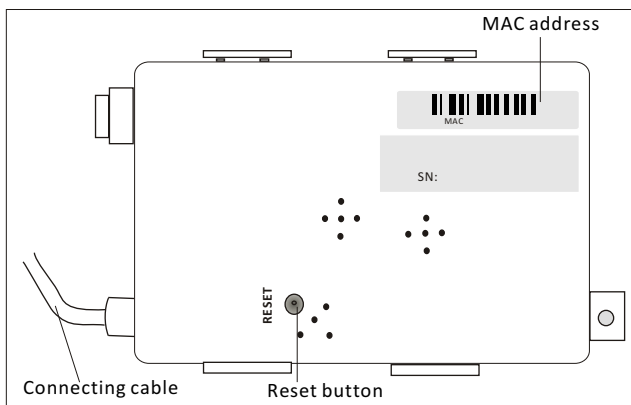

# Downloading and Installing the App

## 1. Install the APP for Android Smart phone

**Step1.** Tap the "Play Store" icon on the Smart phone.



**Step2.** Type "Intelligent AC" in the search window and search the app.

**Step3.** Tap the "INSTALL" button.

**Step4.** Tap the "ACCEPT" button to install the APP.

**Step5.** When the app is finished installing, an OPEN button is displayed on the screen. If you are ready to use it ,tap "OPEN" to start it.

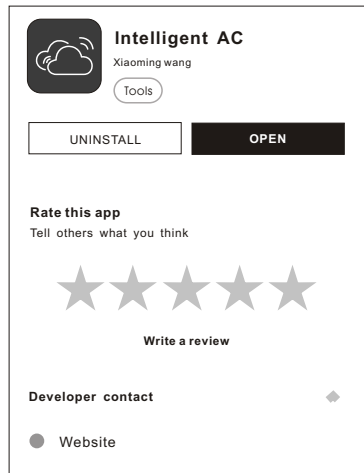
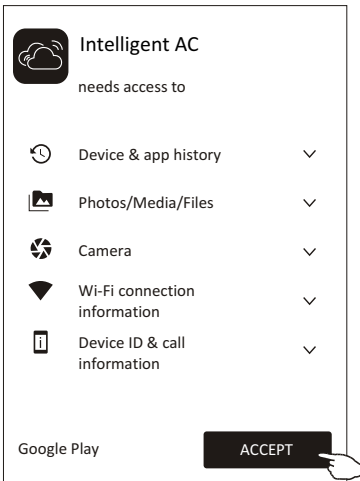
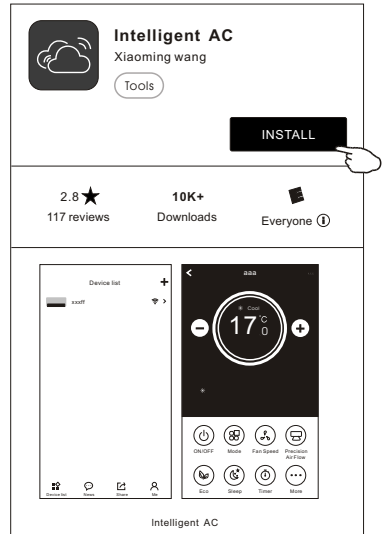



# Downloading and Installing the App

## 2.Install the APP for iPhone(IOS system)

**Step1.** Tap the "APP Store"icon on the iPhone.



App Store

**Step2.** Type "intelligent ac" in the search window and search the app.

**Step3.** Tap the button  to download and install the APP.

**Step4.** When the app is finished installing, an OPEN button is displayed on the screen. If you are ready to use it ,tap "OPEN" to start it.

## 3.Another way to download and Install the APP

**Step1.** Scan the following QR code.

**Step2.** Tap "Download" on the screen (for iPhone, please enter into the App Store and follow item2 of this topic to finish the installing).



**Step3.** After downloaded the APP, tap"Install" button on the screen or find the"IntelligentAC.apk" in the download lists and open it.

**Step4.** Select "I understand the risk, install anyway" . on the installation screen

**Step5.** Tap"Install anyway" to install APP.

**Step6.** When the app is finished installing, an OPEN button is displayed on the screen. If you are ready to use it ,tap "OPEN" to start it.



*Note: Source UC Browser for above steps ,you can choose other tools.*

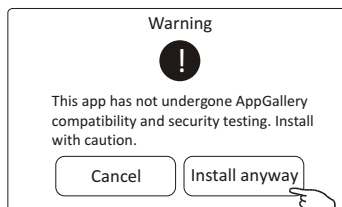
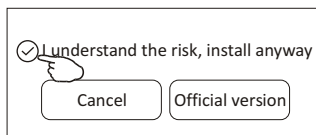
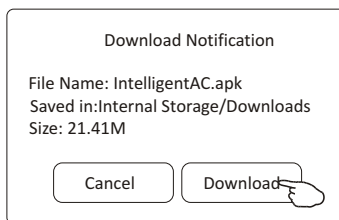

# Activate APP-App settings

1. Launch the APP by tapping the Intelligent AC icon on your smart phone.



Intelligent AC

2. Tap Allow to get permissions of access to camera and storage on the next permissions screen.

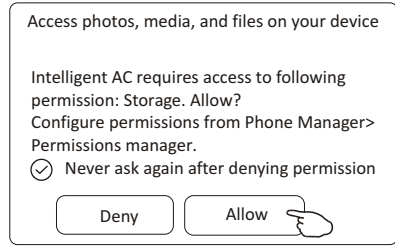
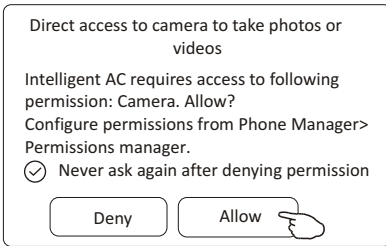

**Note:** if you tap Deny, the app will disable and prompt "Please enable the permission in settings". You can enable the permission in your mobile setting.

3. Once get the permissions, on the next Select Area Of Use screen, please carefully select one of the area and tap Confirm.

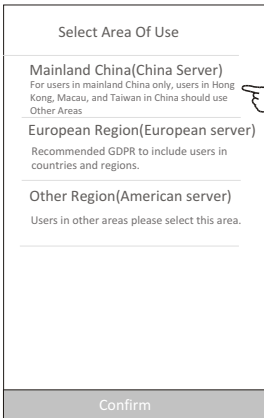

Make sure that the product you use is the same as the local area you choose. Otherwise the product may not work properly

Confirm

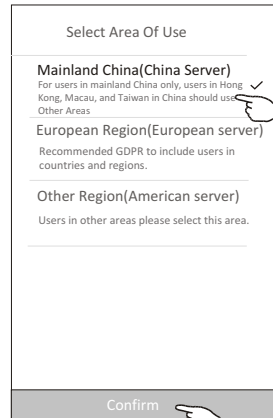

# Activate APP-Activation code and Privacy agreement

4. On the next activation screen, to activate the APP, you can scan the activate QR code directly or choose Manual input and input the activation code .



## Activate QR code and activation code

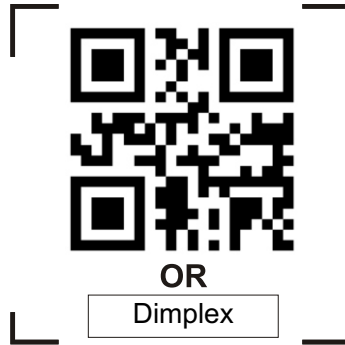

## Scan the QR code or Manual Input

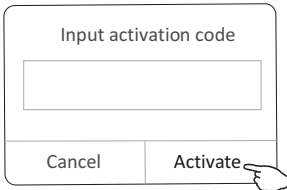

*Note: Without the QR code or activation code, you can't activate the APP and using it, please keep them safe.*

5. Please tap Allow on the next Access to location screen after activation .

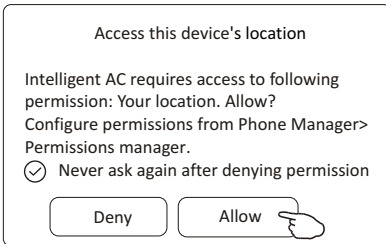

6. Welcome screen and Privacy Agreement screen will POP up , please check the privacy carefully and tap Agree.

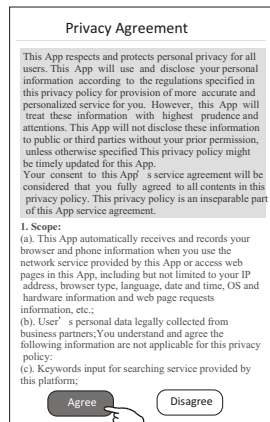

# Login-Registration for new user

- 1.For the new installation of APP, the login screen will appear after Privacy agreement.  
For a new login, it will appear after launching and welcome screen.
- 2.If you don't have any account please tap Register.
- 3.Tap country calling code of you phone number like "+86".
- 4.Slide the screen or find the country of your mobile phone number located.  
Tap the country like China +86.
- 5.Input your mobile phone number and create a password  
(Password must including 6~20 characters and numbers)
- 6.Tap Get verification code and a message with verification code will be received on your smart phone soon .
- 7.Input the verification code within 59s.
- 8.Tap Complete when done.

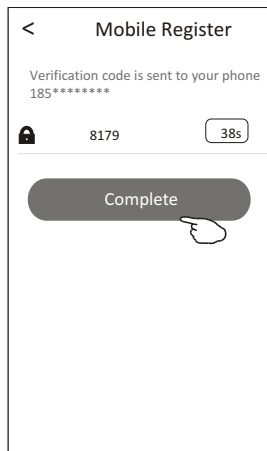
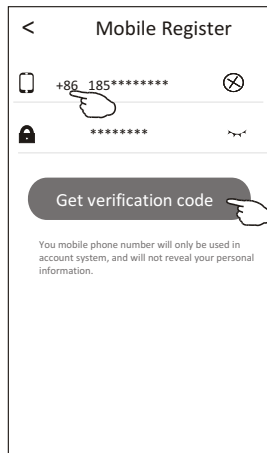
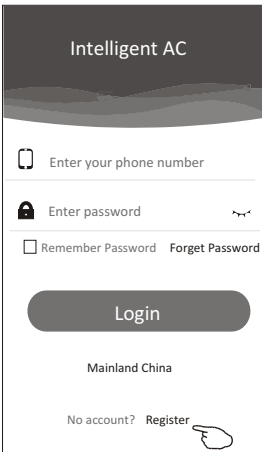

Message sample

[Intelligent AC verification code]: you are now using SMS to obtain Intelligent AC authentication code, verification code is 8179

# Login-Forget the Password

- 1.If you forget the password to login please tap **Forget Password**.
- 2.Input your mobile phone number and create a new password (Must including 6~20 characters and numbers).
- 3.Tap **Get verification code**.
- 4.Input the verification code( included in the message received on your smart phone) within 59s.
- 5.Tap **Complete** to finish the registration.

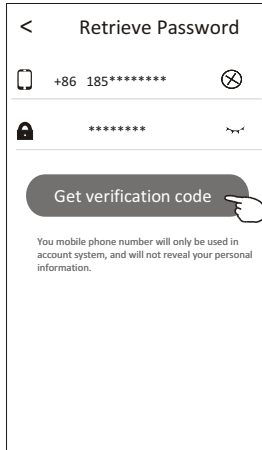
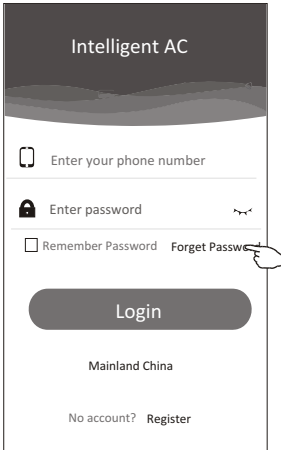

# Login

- 1.Input your mobile phone number and password.
- 2.Tap **Login**.

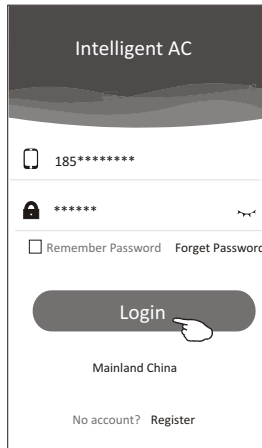

# Add device

1. Click + in the upper right corner of the Device list screen, then tap Add Device.
2. Power on the indoor unit (Launching the Air conditioner is not required) and follow up the instruction on 1/5 screen or press restart button of the Wi-Fi module to restart the Wi-Fi module. Tap next on 1/5 screen.
3. Input the Wi-Fi name and password, the same as your smart-phone connected, tap Connect.
4. You can see the percent rate of connecting process, at the same time "PP", "SA", "AP" shining in turn on the indoor display.  
"PP" means "searching the router"  
"SA" means "connected to the router"  
"AP" means "connected to the server"
5. When finished the configuration it will get into 4/5 and 5/5 screen automatically.
6. Input the name of this device and tap Complete on 5/5 screen.  
The device will be listed on the Device list screen when done.

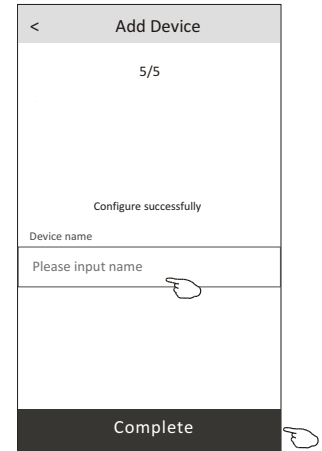
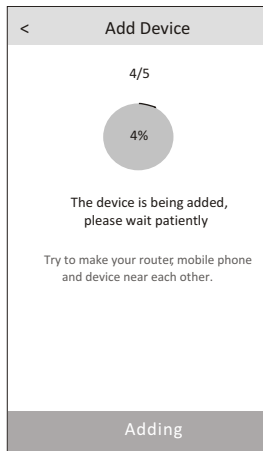
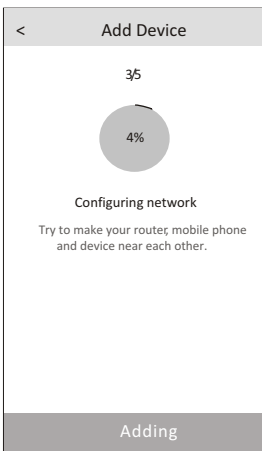
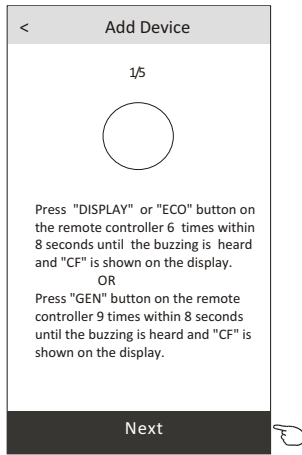
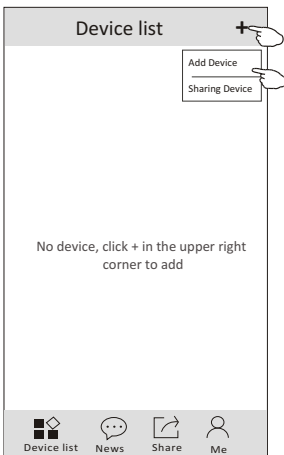

# Air conditioner control-Main control screen

Tap the name of one device, it will get into the main control screen of the device.

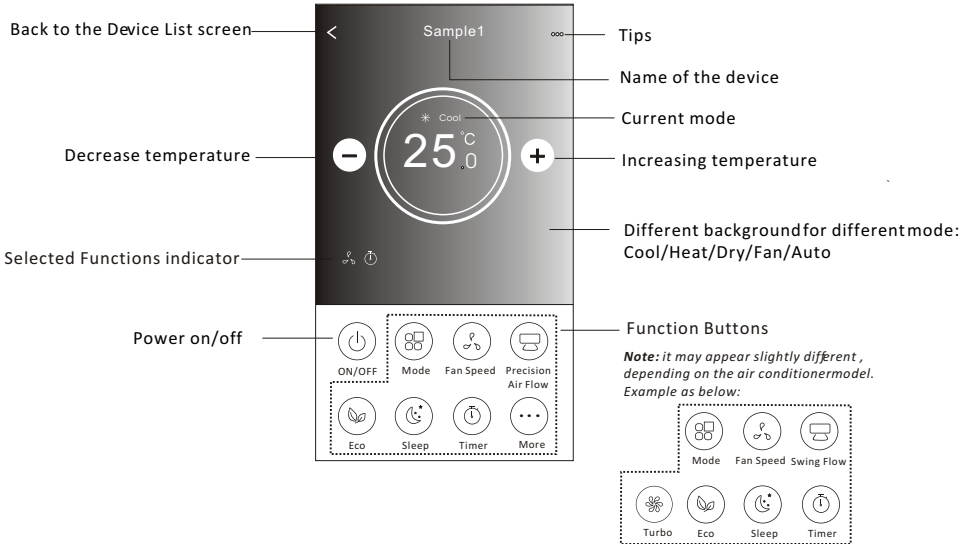
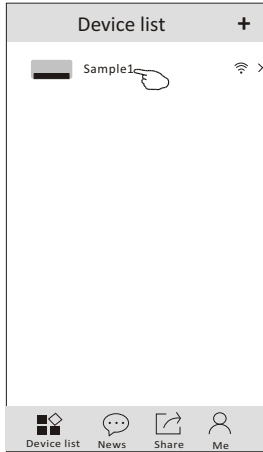

# Air conditioner control-Mode

1. Tap the Mode button.
2. There are 5 modes on the Mode screen, tap one button to set the Air conditioner working mode.
3. Tap the X button to back to the main control screen.
4. The mode and background will change on the screen.

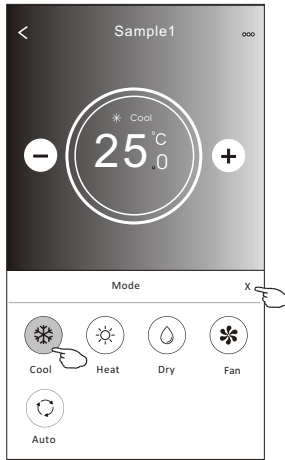

**Note:** please read the details of each mode in the user manual to control more comfortable.

# Air conditioner control-Fan Speed

1. Tap the Fan speed button.
2. Choose your desired fan speed and tap it.
3. Tap the X button to back the main control screen.
4. The selected fan speed indicator will appear on the screen.

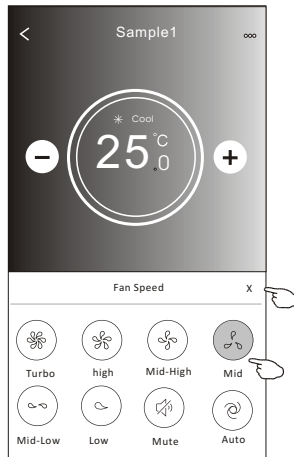
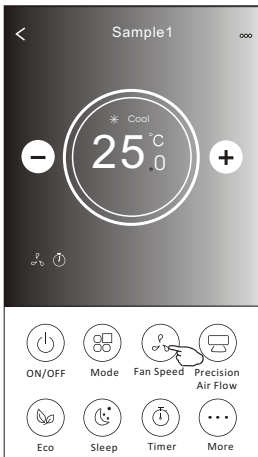

Mode	Fan Speed
Cool	All speeds
Fan	All speeds
Dry	
Heat	All speeds
Auto	All speeds

**Note:**  
Fan Speed can't be adjusted on Dry mode.

**Note:** Fan Speed screen may appear slightly different, depending on the air conditioner model.  
Example as below:

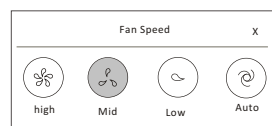



# Air conditioner control-Air Flow control

1. Tap the Precision Air Flow button or Swing Flow button.
2. Choose your desired air flow and tap it.
3. Tap the X button to back to the main control screen.
4. The selected air flow indicator will appear on the screen.

**Note:** For some models without auto Left-Right wind, if you active it, you will hear a beep, but no any actions.

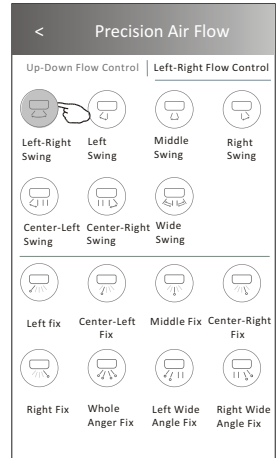
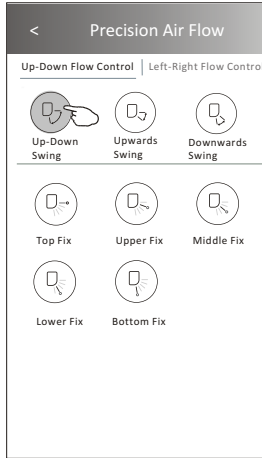

**Note:** The Main controlscreen and Air Flowscreen may appear slightly different, depending on the air conditioner model.  
Example as below:

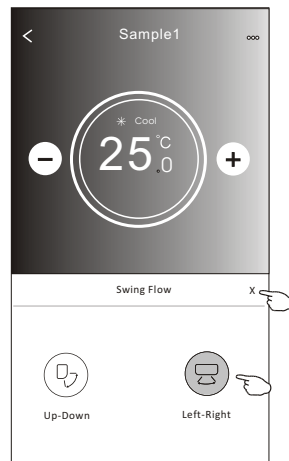
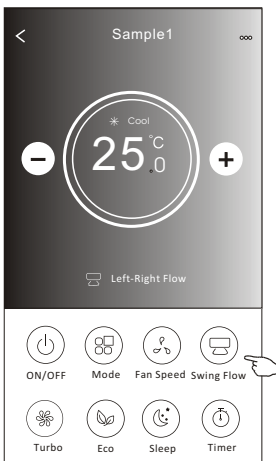

# Air conditioner control-ECO

1. For Eco function, just tap the button to activate the function, the button will be lighting and the indicator will appear on the screen.
2. Tap again to disable the function.
3. Temperature controlled for some air conditioner model:  
In Cooling mode, the new setting temperature will  $\geq 26^{\circ}\text{C}$ .  
In heating mode, the new setting temperature will  $\leq 25^{\circ}\text{C}$ .

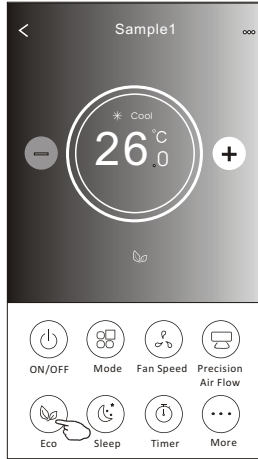
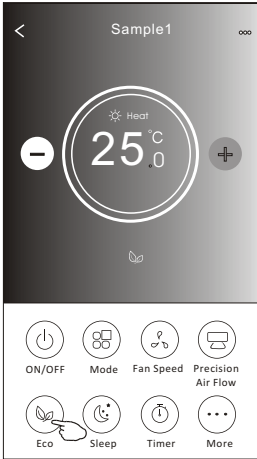

Mode	ECO enabled
Cool	Yes
Fan	
Dry	
Heat	Yes
Auto	

ECO is disabled on Fan/ Dry/Auto mode .

**Note:** The Main controlscreen and ECOcontrol method may appear slightly different, depending on the air conditioner model. Example as below:

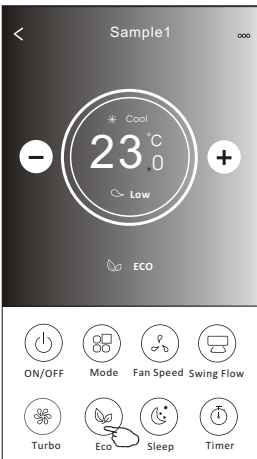

**Note:**  
ECO is disabled on Turbo/Sleep mode too for some air conditioner model.

# Air conditioner control-Sleep

1. Tap the Sleep button.
2. Choose your desired sleep mode and tap it.
3. Tap the X button to back to the main control screen.
4. The selected sleep mode indicator will appear on the screen.

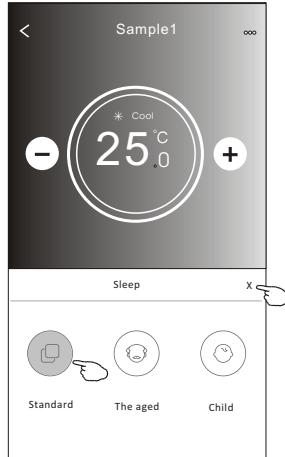
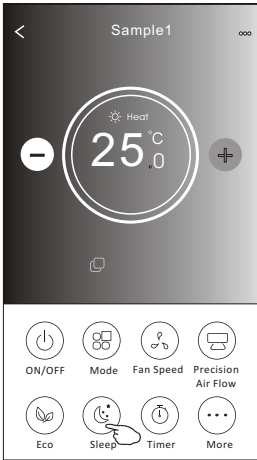

Mode	Sleep enabled
Cool	Yes
Fan	
Dry	
Heat	Yes
Auto	

Sleep is disabled on Fan/ Dry/Auto mode .

## Note:

The Main controlscreen may appear slightly different ,depending on the air conditioner model.  
Example as below:

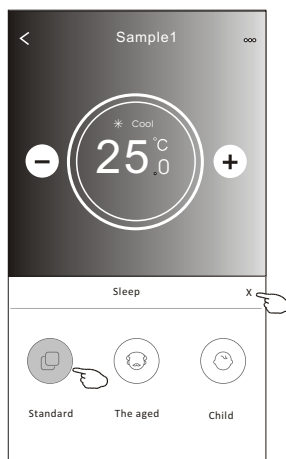
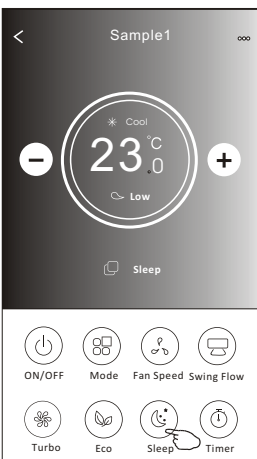

## Note:

Sleep is disabled on Turbo/Sleep mode too  
for some air conditioner model..

# Air conditioner control-Timer(Off)

1. Tap the Timer button.
2. Tap + in the upper right corner of the Timer main screen.
3. Choose the Time/Repeat/Switch OFF then tap Save.
4. The timer(off) will appear on the Timer main screen.

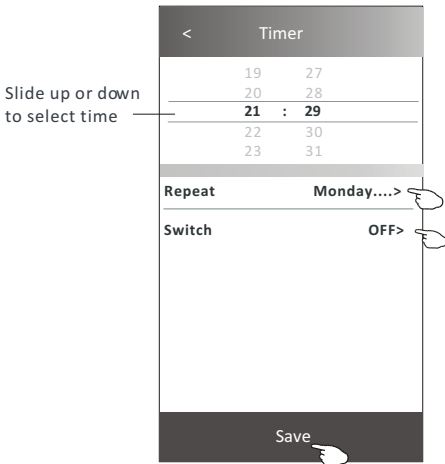
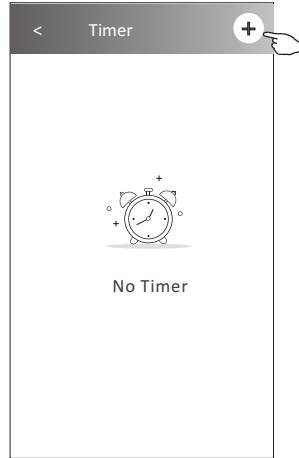

Tap repeat> then tap your desired repeat days or Once, then tap Confirm your selection.

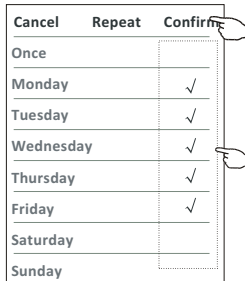

Tap Switch> then slide the screen to choose ON and Confirm.

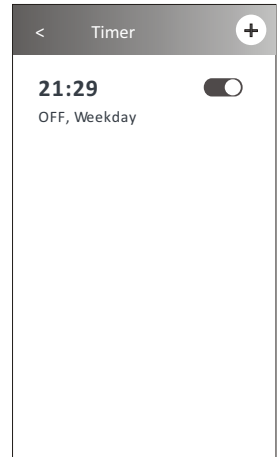
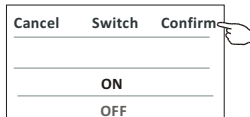

# Air conditioner control-Timer(On)

1. Tap the Timer button.
2. Tap + in the upper right corner of the Timer main screen.
3. Set the Time/Repeat Date/Switch(ON)/Temperature/Mode/  
Fan speed/Air Flow as your desired and then tap Save.
4. The timer will appear on the Timer main screen.

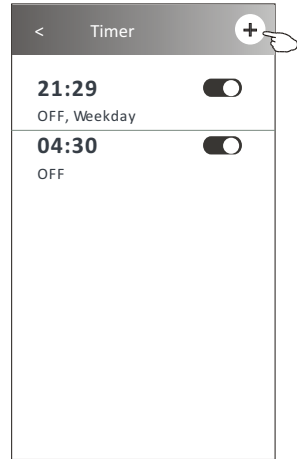
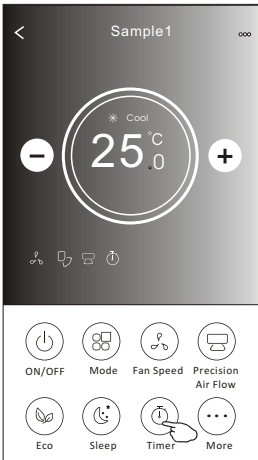

Slide up or down to select time

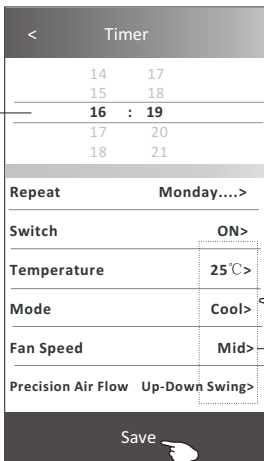

Tap repeat> then tap your desired repeat days or Once, then tap Confirm your selection.

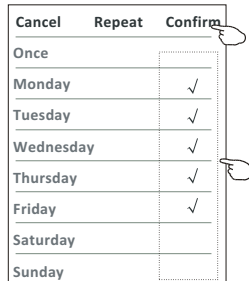

Tap Switch> then slide the screen to choose ON and Confirm.

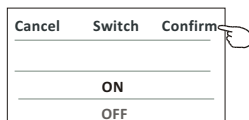

Tap Temperature/Mode/Fan Speed/ Air Flow > one by one then setas your desired as mentioned on the previous chapter and tap Confirm the setting.

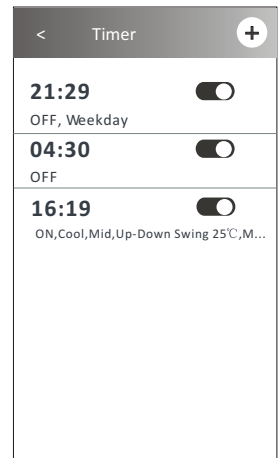

# Air conditioner control-Timer(change /disable /delete)

## 1.Change the Timer setting:

Tap anywhere of the timer list bar except the switch bar to get into the Timer setting screen, change the setting and then tap save.

## 2.Enable or Disable the Timer:

Tap the left of the switch to disable the Timer.

Tap the right of the switch to enable the Timer.

## 3.Delete the Timer:

Slide the list bar of the Timer from right to left until Delete button appear, then tap delete.

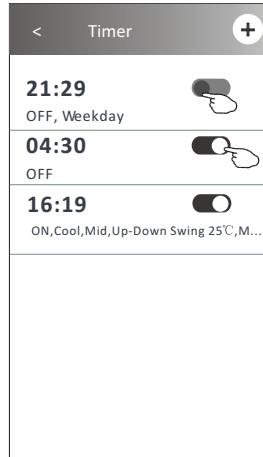
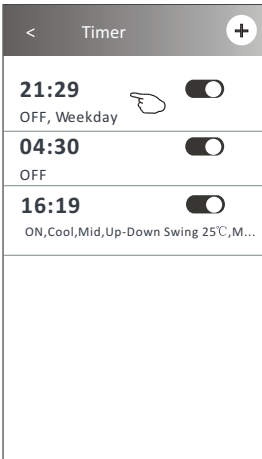

Slid left to disable the Timer.

Slid right to enable the Timer.

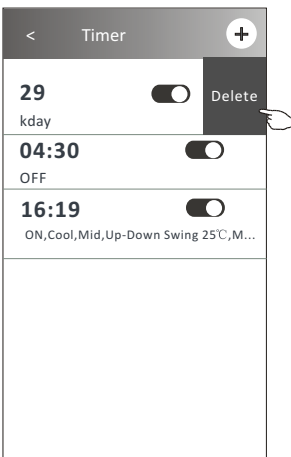

# Air conditioner control-More(Additional functions)

1. Tap the More button to operate additional functions if it appears on the screen.

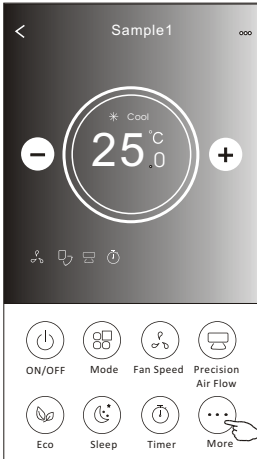

**Note:**  
Some air conditioner model don't have the more button.

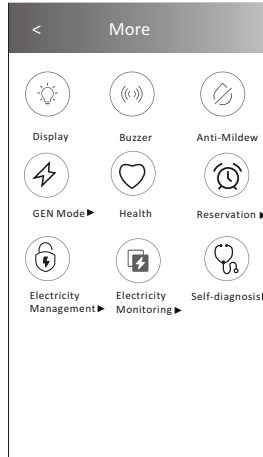

**Note:** The appearance maybe different , some icons will be hidden if the air conditional do no have this function or do not enable on the current mode.

2. Tap the "Display" to switch on/off the indoor LED display.

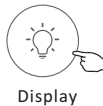

Display

3. Tap the "Buzzer" to switch on/off the buzzing when operating through Wi-Fi APP.



Buzzer

4. Tap the "Anti-Mildew" button to activate the Anti-Mildew function, if it is available on the screen.  
After AC turning off , it will start drying , reduce residual moisture and prevent mould, after function finish, it will automatically turn off.



Anti-Mildew

5. Tap the "Health" button to switch on/off the healthy function, if it is available on the screen.  
It activate the antibacterial ioniser function.  
This function only for models with the ioniser generator.



Health

# Air conditioner control-Additional functions(More)

6. Tap the "GEN Mode" button, if it is available on the screen.

In this Mode, you can choose one of the three levels of current.

The air conditioner will maintain proper current to save energy.

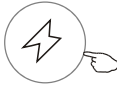

GEN Mode▶

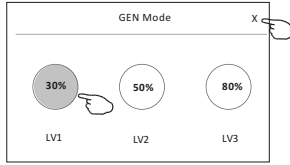

7. Tap the "Electricity Monitoring" button if it is available on the screen.

In this function, you can monitor the air conditioner electricity consumption.



Electricity Monitoring ▶

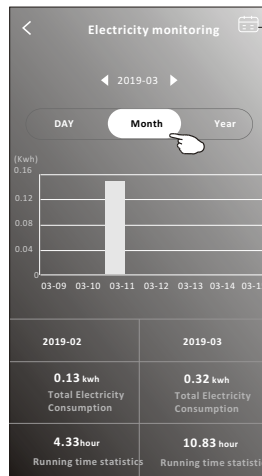
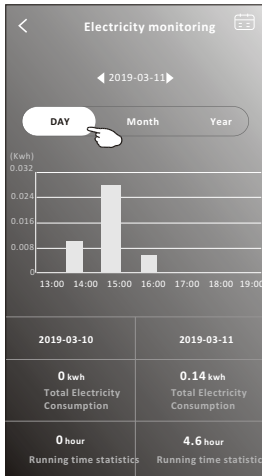

You can tap this button to pop up the calendar then select the date.

8. Tap the "Self-Cleaning" button, if it is available on the screen.

Check the details of the Self-Cleaning function on User Manual.



Self-Cleaning

9. Tap the "8°C Heat" button, if it is available on the screen.

This function help keep the room temperature over 8°C.

Check the details of the 8°C Heat function on User Manual.



8°C Heat



## Air conditioner control-Additional functions(More)

10. Tap the "Reservation" button , if it is available on the screen.

You can set the time, repeat day, temperature, mode, fan speed, air flow as you desired and then tap Save to activate the function.

The air conditioner will automatically reach your settings at the appointment time.

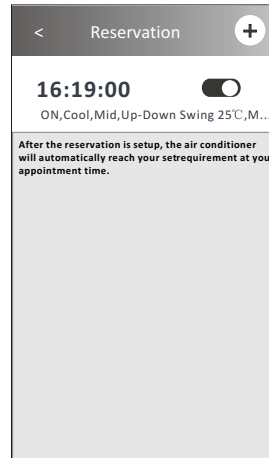
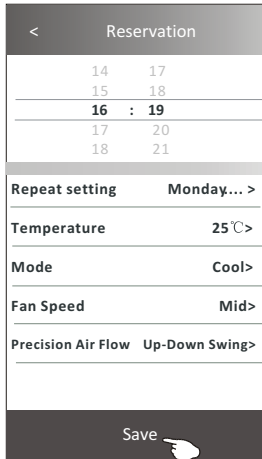
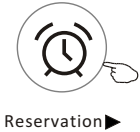

11. Tap the "Self-diagnosis" button, if it is available on the screen.

The air conditioner will automatically diagnosis itself and indicate the Error code and the problem instructions if possible.

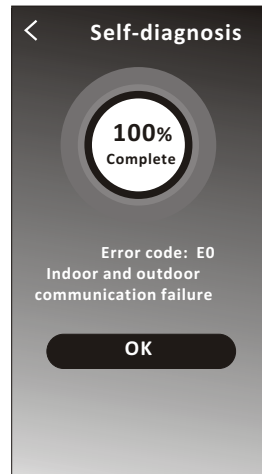
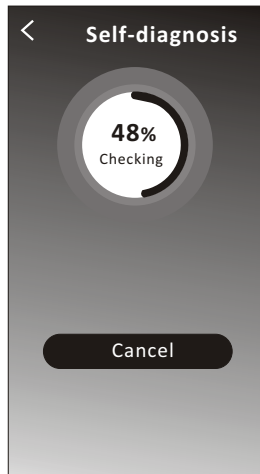

# Air conditioner control-Additional functions(More)

12. Tap the "Electricity Management" button if it is available on the screen.



Electricity Management ▶

Fix Mode	Air conditioner actions
Default mode	AC auto operate.Ultimate smart energy saving, have a comfortableand cooling sleep atnight.
Fixed Electricity	AC auto operateas per the fixedelectricity power, theuser can select thefixed electricity power every night.
Fixed Temp	AC auto operateas per the fixed temp,the user can select different temp everynight.

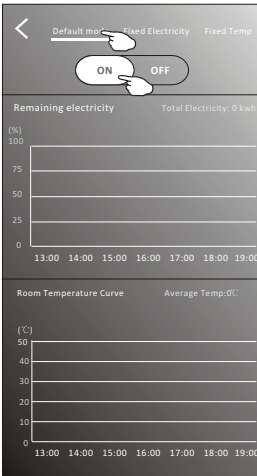

1.Choose Default mode

2.Switch ON

The other 2 modes will be deactivate.

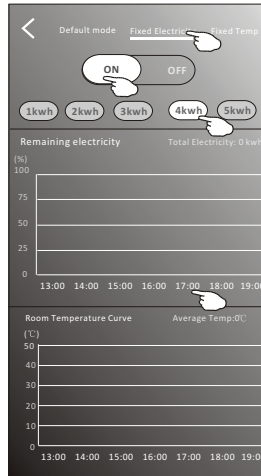

1.Choose Fix Electricity mode

2. Select the fixedpower consumption

3.Switch ON

The other 2 modes will be deactivate.

The time can be slideleft or right to show morelist.

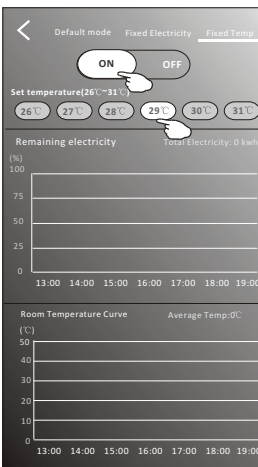

1.Choose Fix Tempmode

2. Select the fixedtemperature

3.Switch ON

The other 2 modes will be deactivate.

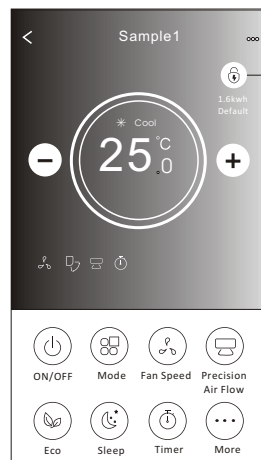

Electricity Management indicator

# Tips of the device

Tap . . . in the upper right corner of the device main screen.

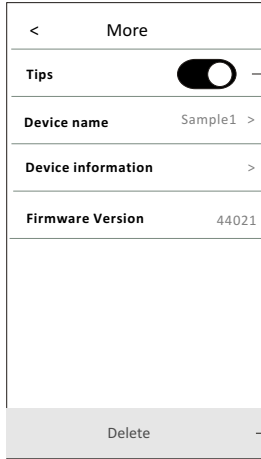
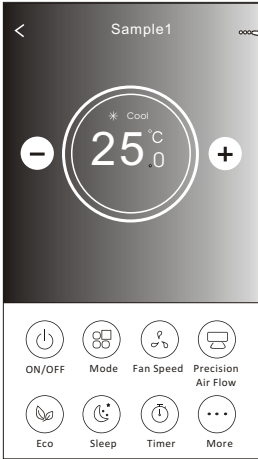

Tap right of the bar to switch on/off the tips below.

Tap to Edit name (rename).

Tap to get the device information.

Tap to delete the device.

Device information	
PID	00000xxxxxx
DID	00000xxxxxx
MAC	34.ea.xxxxxx
Device IP	192.168.xxxxxx
Access cloud	106.xxxxxx
Data cloud	47.xxxxxx
Copy all	

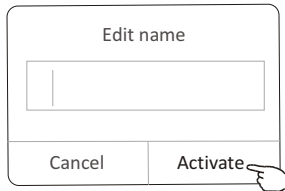

Input the new name and tap Activate.

# News

1. Tap News in the bottom of the device list screen.

2. Tap the device name and you can check the news of the device when operation.

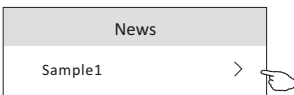

# Share the device

## 1. Online, Offline

📶 Online, You can control the air conditioner through Wi-Fi without Internet in the same Wi-Fi home network, or you can control the air conditioner through Internet base on mobile network (3G/4G) or other Wi-Fi resources.

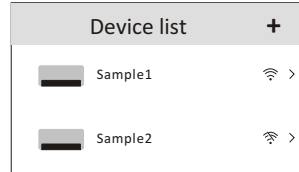

📶 The air conditioner is off or connecting issue.

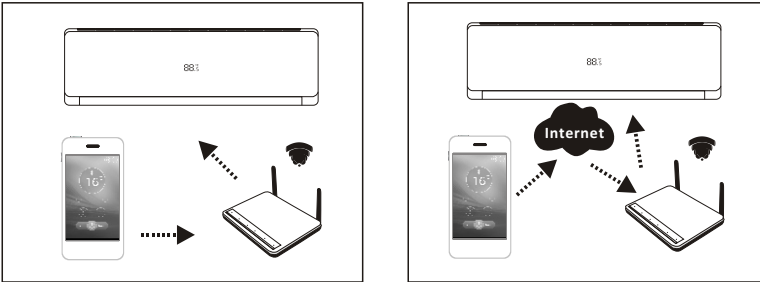

2. Tap Share in the bottom of the device list screen.

3. Tap Sharing device.

4. Tap share and send the QR code to other people.

5. Other people have to get into the Device Sharing screen of this APP to use the integrate scanner to scan the QR code.

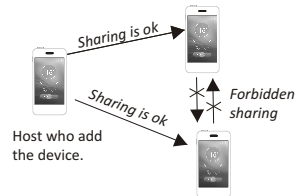

## Scanner

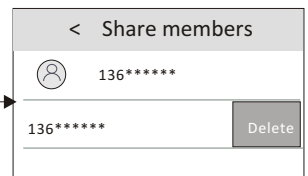
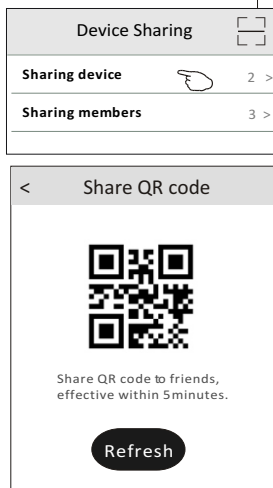
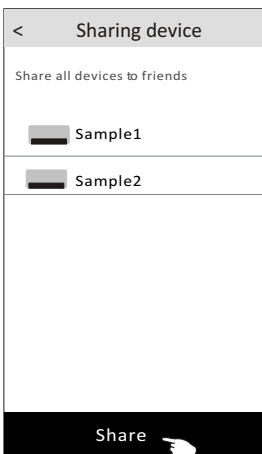



Slide the name from left to right  
Tap Delete to remove the sharing member

Note:  
It's a sample, don't scan. Scan the sharing QR code on your friend phone.  
And must use the integrate scanner.

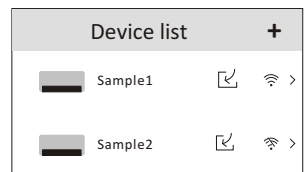
Tap Refresh if QR code is noneffective.



# Account and Help

1. Tap  in the bottom of the device list screen.
2. Tap  to take or choose a picture for your account.
3. Tap your account name to edit the name.
4. Tap setting to change your login password if possible.
5. Tap About to check the APP version and Backstage Server.
6. Tap Help to get some operate instructions and solutions of problems.

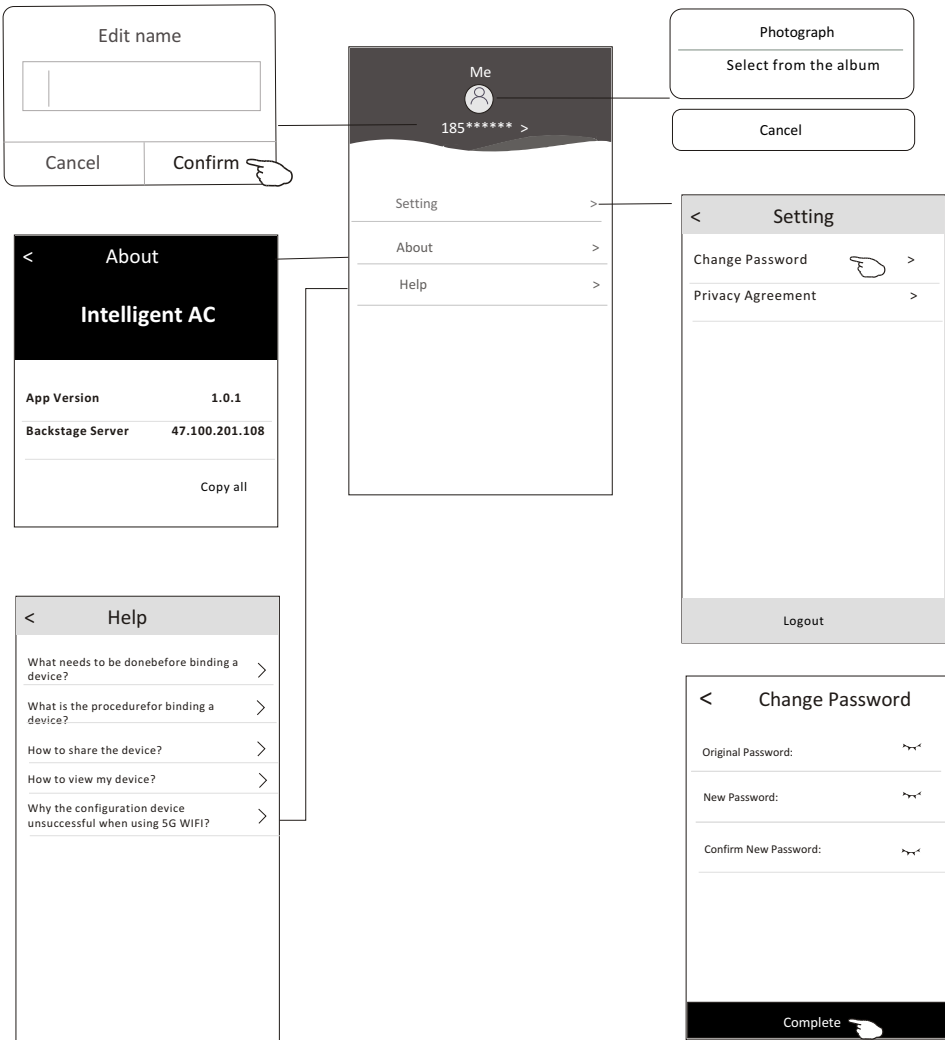
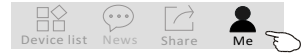

Tap complete to confirm the change

## Notice

1. For technical update, there is maybe deviation of the actual items from what is on the manual. We express our apologies. Please refer to your actual product and APP.
2. Smart air conditioner APP can be altered without notice for quality improvement and also be deleted depending on the circumstances of manufacturing firms .
3. In case Wi-Fi signal strength is weakened, smart App may be disconnected. So make sure the indoor unit near to wireless router.
4. DHCP server function should be activated for wireless router.
5. The internet connection may fail because of a firewall problem. In this case, contact your internet service provider.
6. For smart phone system security and network setting, make sure Smart air conditioner APP is trusted.

## Trouble Shooting

Description	Analysis of cause
<b>Air conditioner can't be configured successfully</b>	<ol style="list-style-type: none"><li>1. Check the mobile connected Wi-Fi address and password is correct;</li><li>2. Check the air conditioner under configuration status;</li><li>3. There are any firewall or other restrictions have been set or not;</li><li>4. check the router work normally;</li><li>5. Make sure air conditioner, router and mobile work within signal scope;</li><li>6. Check router shielding App or not;</li></ol>
<b>Mobile can't control air conditioner</b>	<p>Software display: Identification failed, It means the air conditioner has been reset, and the mobile phone lost control permission.</p> <p>You need to connect Wi-Fi to get permission again. Please connect the local network and refresh it. After all still can't work, please delete air conditioner and wait its refresh.</p>
<b>Mobile can't find air conditioner</b>	<p>Software display: Air conditioner out of line. Please check network working;</p> <ol style="list-style-type: none"><li>1. The air conditioner has been reconfiguration;</li><li>2. Air conditioner out of power;</li><li>3. Router out of power;</li><li>4. Air conditioner can't connect to router;</li><li>5. Air conditioner can't connect to network through the router (under remote control mode);</li><li>6. Mobile can't connect to router(Under local control mode);</li><li>7. The mobile phone can't connect to network (under remote control mode).</li></ol>